

Miniature Rocker Switch

Q-9015

TYPE: **MRS-111-1C**

SPECIFICATIONS

Rating: 6A 125V AC; 3A 250V AC
 Contact R: 35mΩ max
 Insulation R: 500V DC 100MΩ min
 Dielectric Strength: 1 Minute 1500V AC
 Operating Temperature: -25°C ~ +85°C
 Electrical Life: 10, 000 Cycles

Outline Drawing

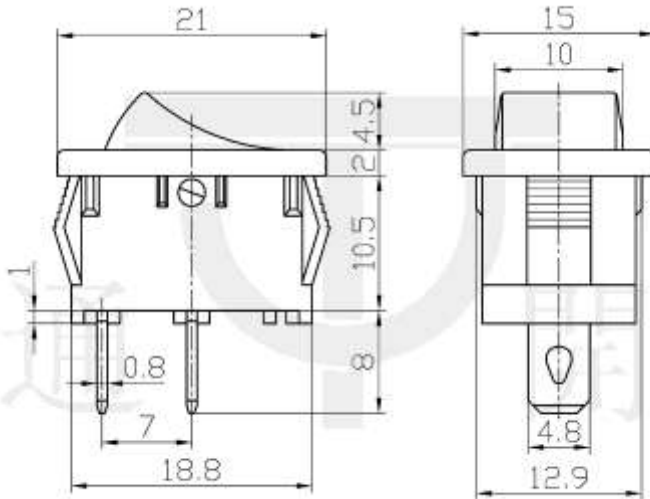

Mounting

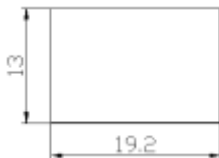

Circuitry

