

BLA-265

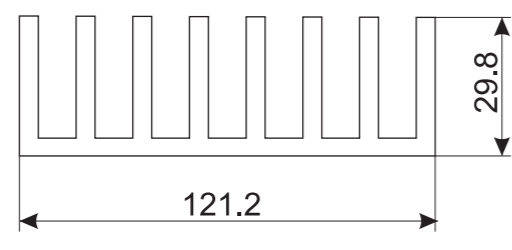

BLA-266

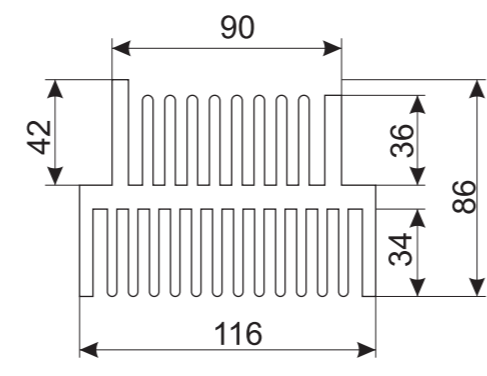

BLA-267

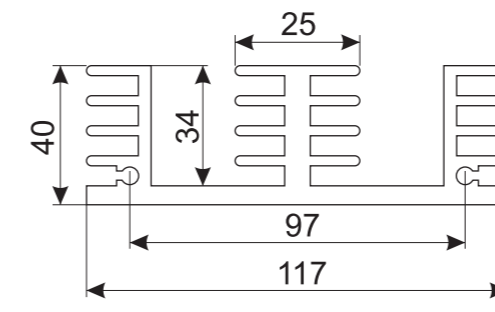

BLA-268

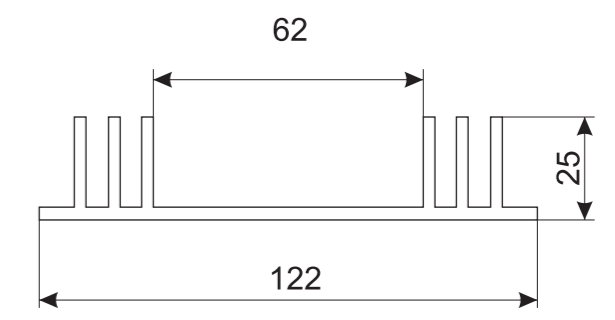

BLA-269

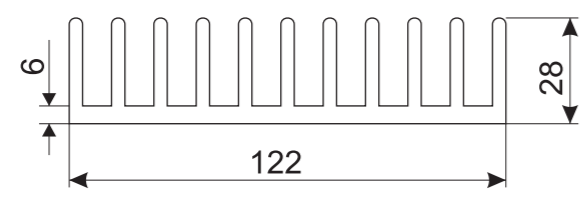

BLA-270

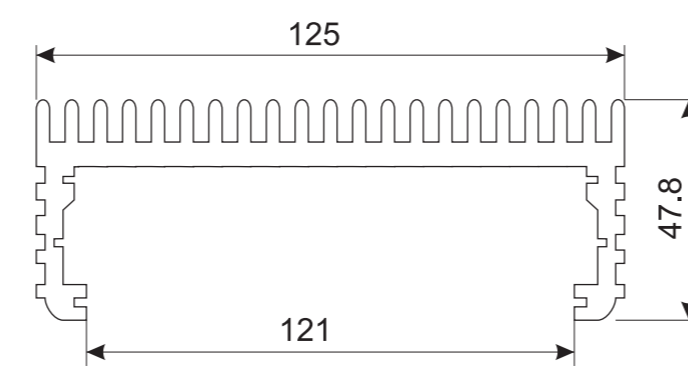

BLA-271

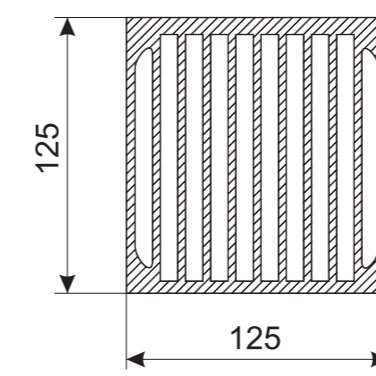

BLA-272

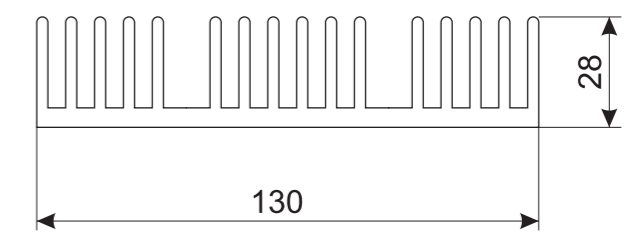

BLA-273

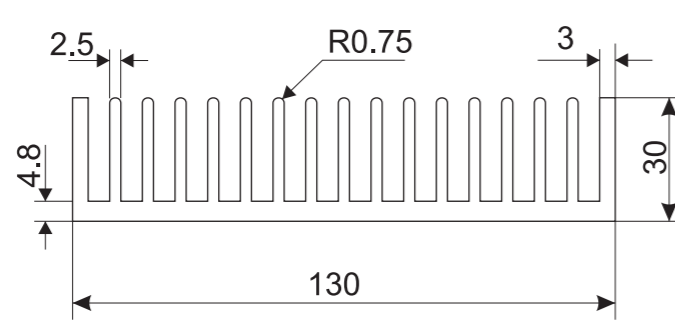

BLA-274

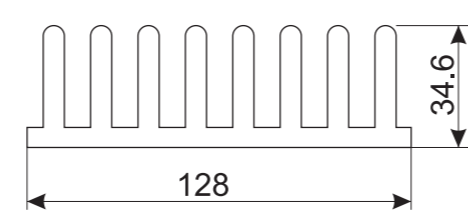

BLA-275

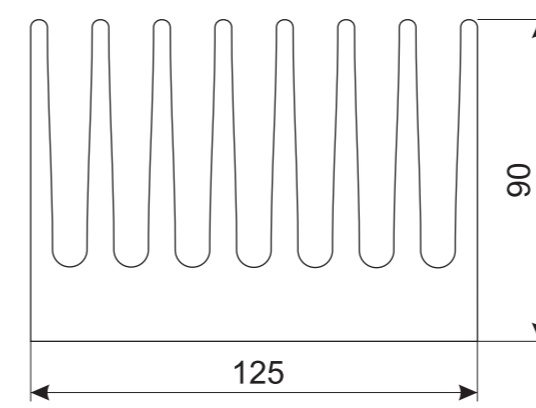

BLA-276

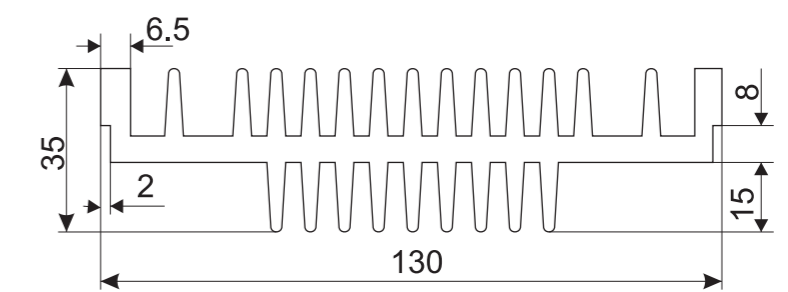

BLA-277

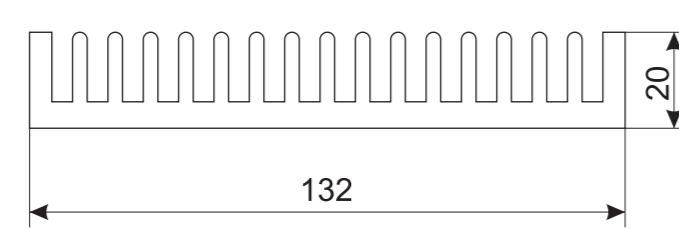

BLA-278

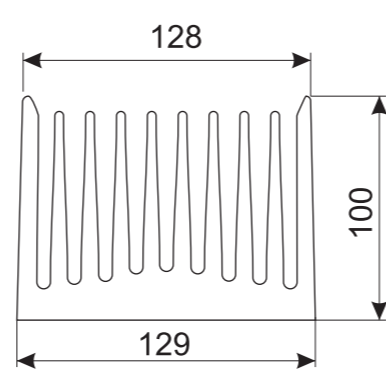

BLA-279

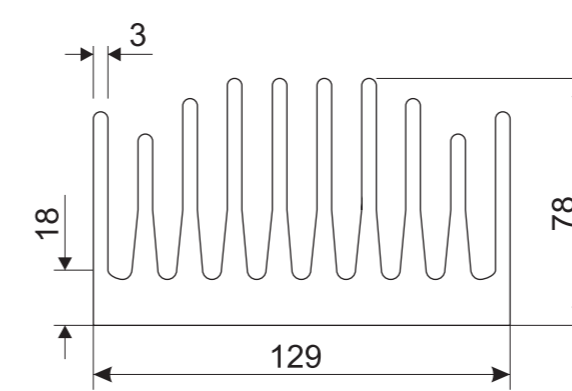

BLA-280

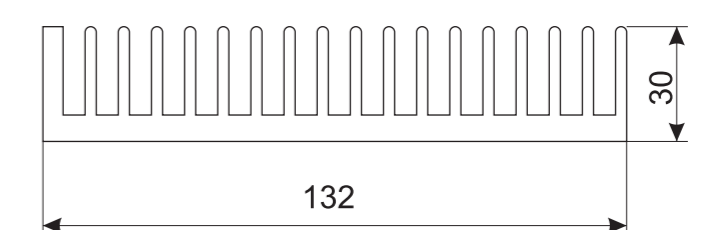

BLA-281

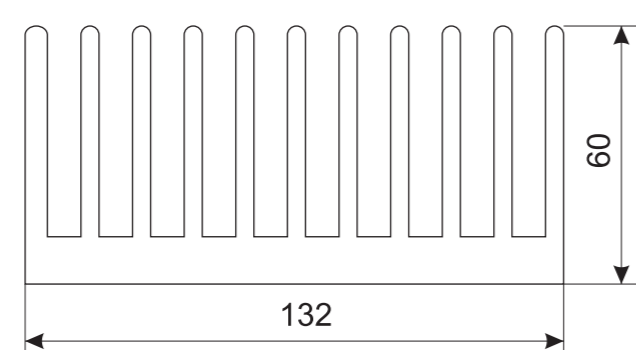

BLA-282

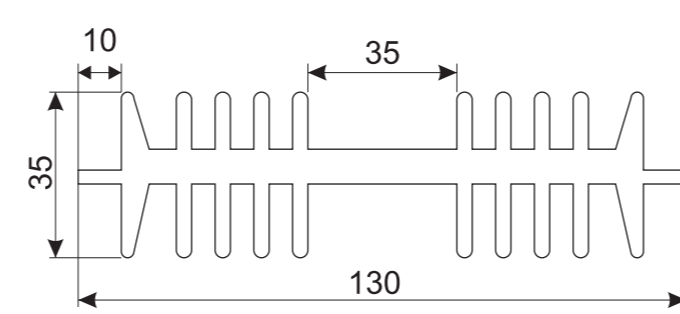

BLA-283

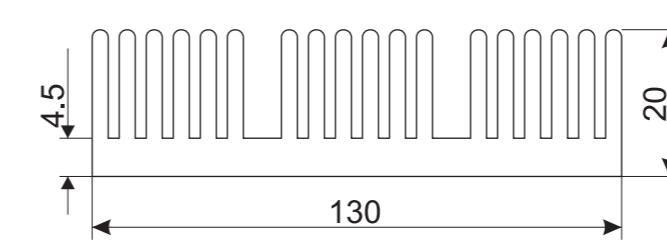

BLA-284

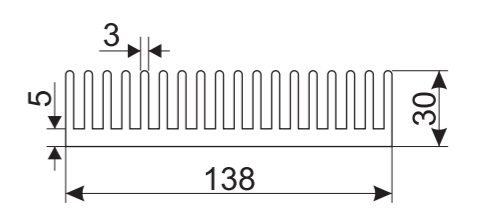

BLA-285

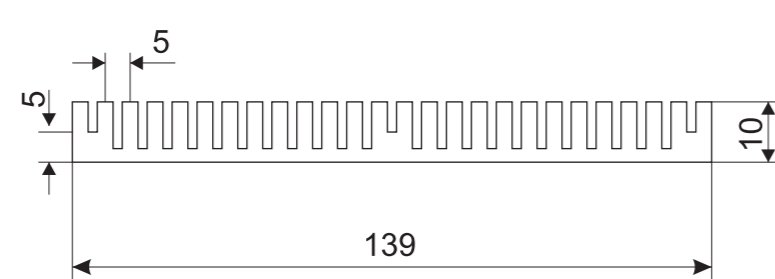

BLA286

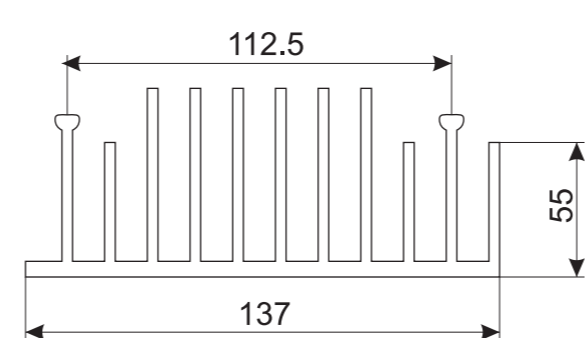

BLA-287

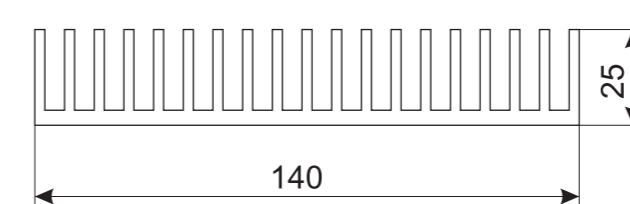

BLA288

