

SHINDENGEN

HVX-2 Series Power MOSFET

N-Channel Enhancement type

2SK2677
(FP10W90HVX2)

900V 10A

FEATURES

- Input capacitance (Ciss) is small. Especially, input capacitance at 0 bias is small.
- The static Rds(on) is small.
- The switching time is fast.
- Avalanche resistance guaranteed.

APPLICATION

- Switching power supply of AC 240V input
- High voltage power supply
- Inverter

OUTLINE DIMENSIONS

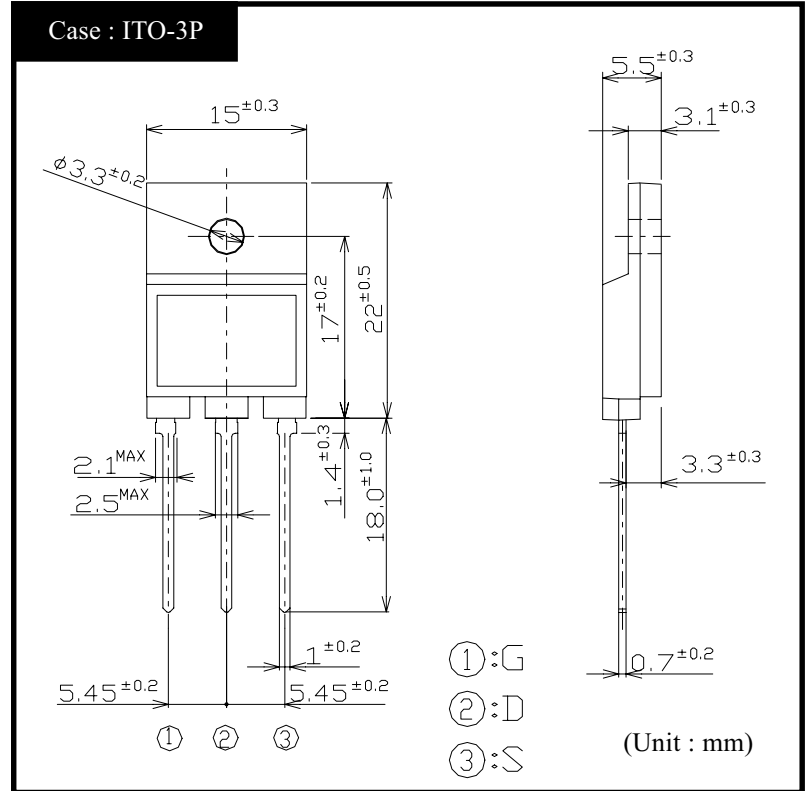

RATINGS

- Absolute Maximum Ratings (Tc = 25°C)

Item	Symbol	Conditions	Ratings	Unit
Storage Temperature	T _{stg}		-55~150	°C
Channel Temperature	T _{ch}		150	
Drain-Source Voltage	V _{DSS}		900	V
Gate-Source Voltage	V _{GSS}		±30	
Continuous Drain Current (DC)	I _D		10	A
Continuous Drain Current (Peak)	I _{DP}	Pulse width ≤ 10 μs, Duty cycle ≤ 1/100	20	
Continuous Source Current (DC)	I _S		10	
Total Power Dissipation	P _T		65	W
Repetitive Avalanche Current	I _{AR}	T _{ch} = 150°C	10	A
Single Avalanche Energy	E _{AS}	T _{ch} = 25°C	260	mJ
Repetitive Avalanche Energy	E _{AR}	T _{ch} = 25°C	26	
Dielectric Strength	V _{dis}	Terminals to case, AC 1 minute	2	kV
Mounting Torque	TOR	(Recommended torque : 0.5 N·m)	0.8	N·m

● Electrical Characteristics $T_c = 25^\circ\text{C}$

Item	Symbol	Conditions	Min.	Typ.	Max.	Unit
Drain-Source Breakdown Voltage	$V_{(BR)DSS}$	$I_D = 1\text{mA}, V_{GS} = 0\text{V}$	900			V
Zero Gate Voltage Drain Current	I_{DSS}	$V_{DS} = 900\text{V}, V_{GS} = 0\text{V}$			250	μA
Gate-Source Leakage Current	I_{GSS}	$V_{GS} = \pm 30\text{V}, V_{DS} = 0\text{V}$			± 0.1	
Forward Transconductance	g_{fs}	$I_D = 5\text{A}, V_{DS} = 10\text{V}$	4.8	8.0		S
Static Drain-Source On-state Resistance	$R_{DS(ON)}$	$I_D = 5\text{A}, V_{GS} = 10\text{V}$		1.05	1.4	Ω
Gate Threshold Voltage	V_{TH}	$I_D = 1\text{mA}, V_{DS} = 10\text{V}$	2.5	3.0	3.5	V
Source-Drain Diode Forward Voltage	V_{SD}	$I_S = 5\text{A}, V_{GS} = 0\text{V}$			1.5	
Thermal Resistance	θ_{jc}	junction to case			1.92	$^\circ\text{C}/\text{W}$
Total Gate Charge	Q_g	$V_{DD} = 400\text{V}, V_{GS} = 10\text{V}, I_D = 10\text{A}$		90		nC
Input Capacitance	C_{iss}	$V_{DS} = 25\text{V}, V_{GS} = 0\text{V}, f = 1\text{MHz}$		2150		pF
Reverse Transfer Capacitance	C_{rss}			50		
Output Capacitance	C_{oss}			210		
Turn-On Time	t_{on}	$I_D = 5\text{A}, R_L = 30\Omega, V_{GS} = 10\text{V}$		140	250	ns
Turn-Off Time	t_{off}			440	740	

2SK2677

Transfer Characteristics

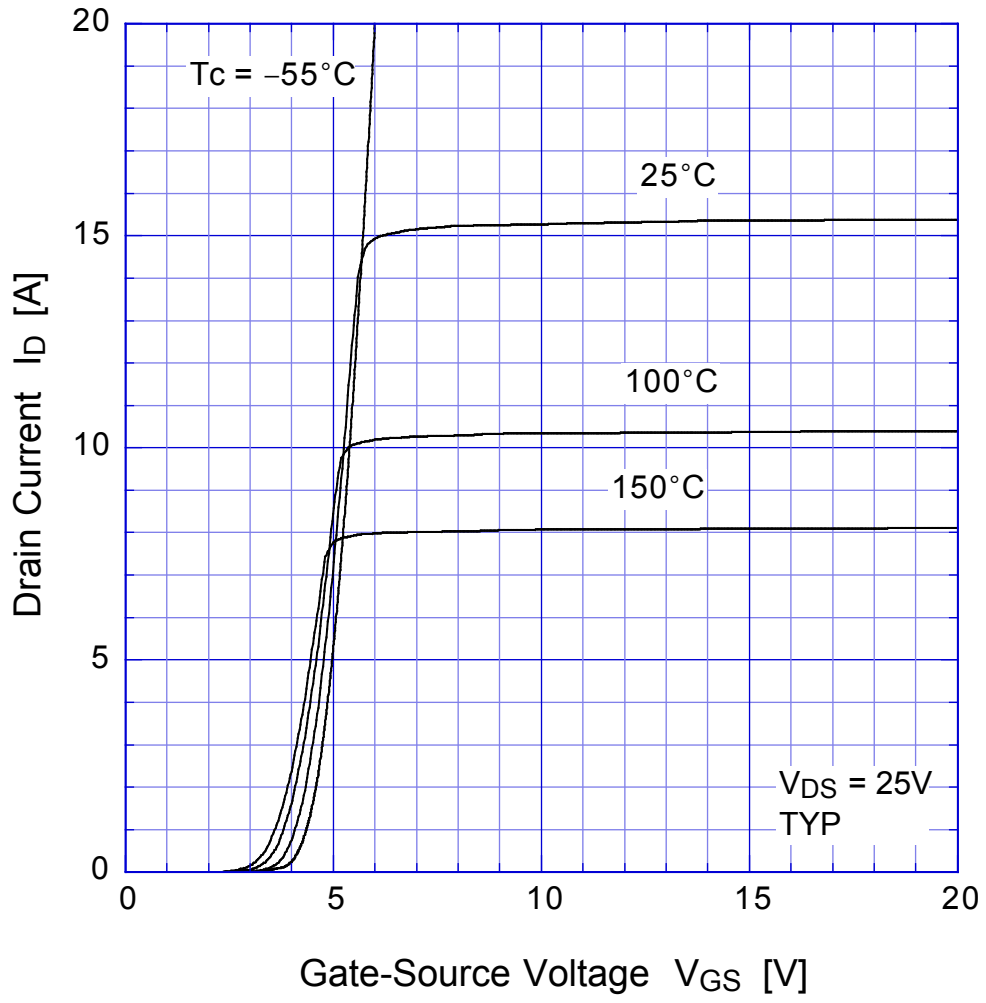

2SK2677 Static Drain-Source On-state Resistance

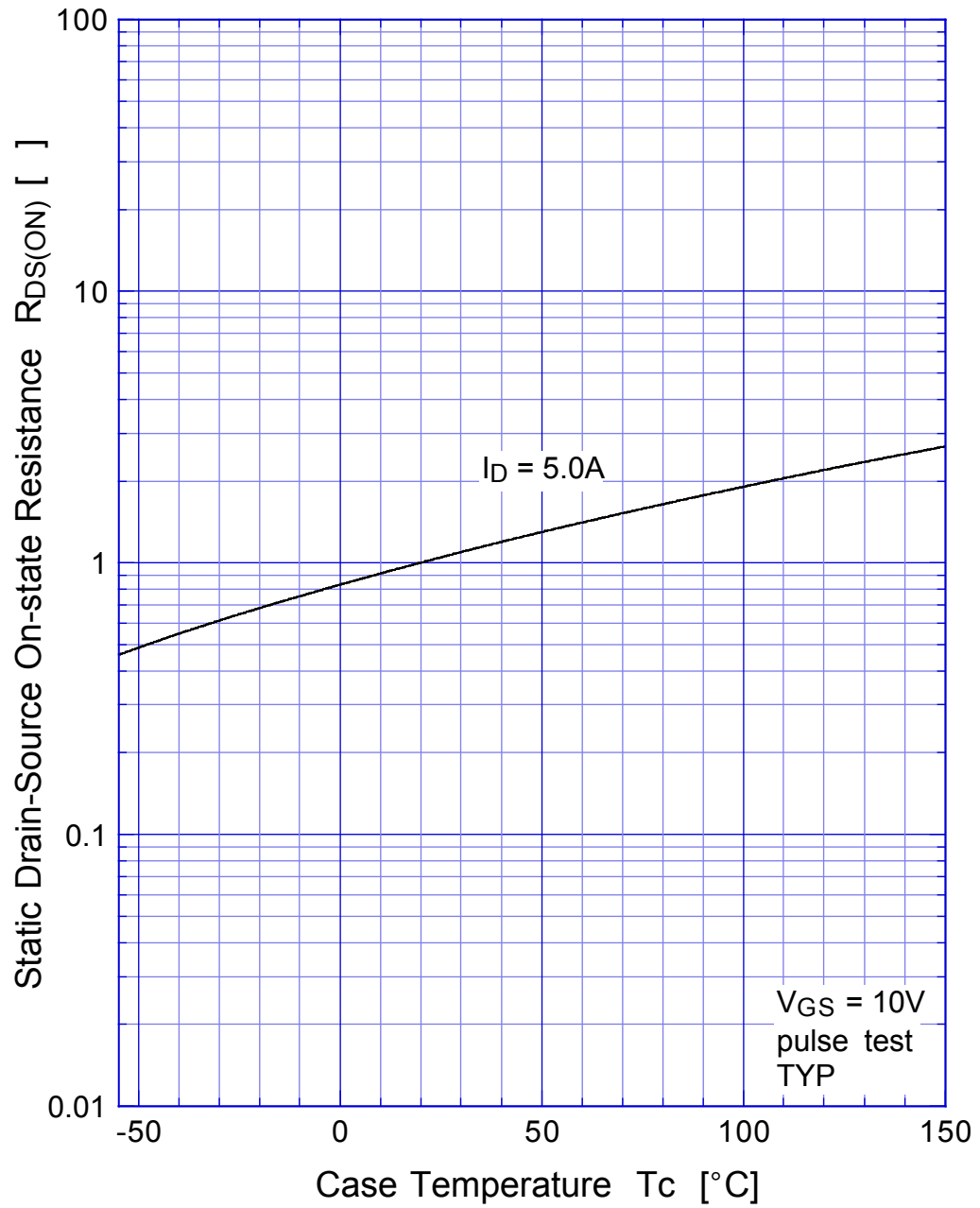

2SK2677 Gate Threshold Voltage



2SK2677 Safe Operating Area

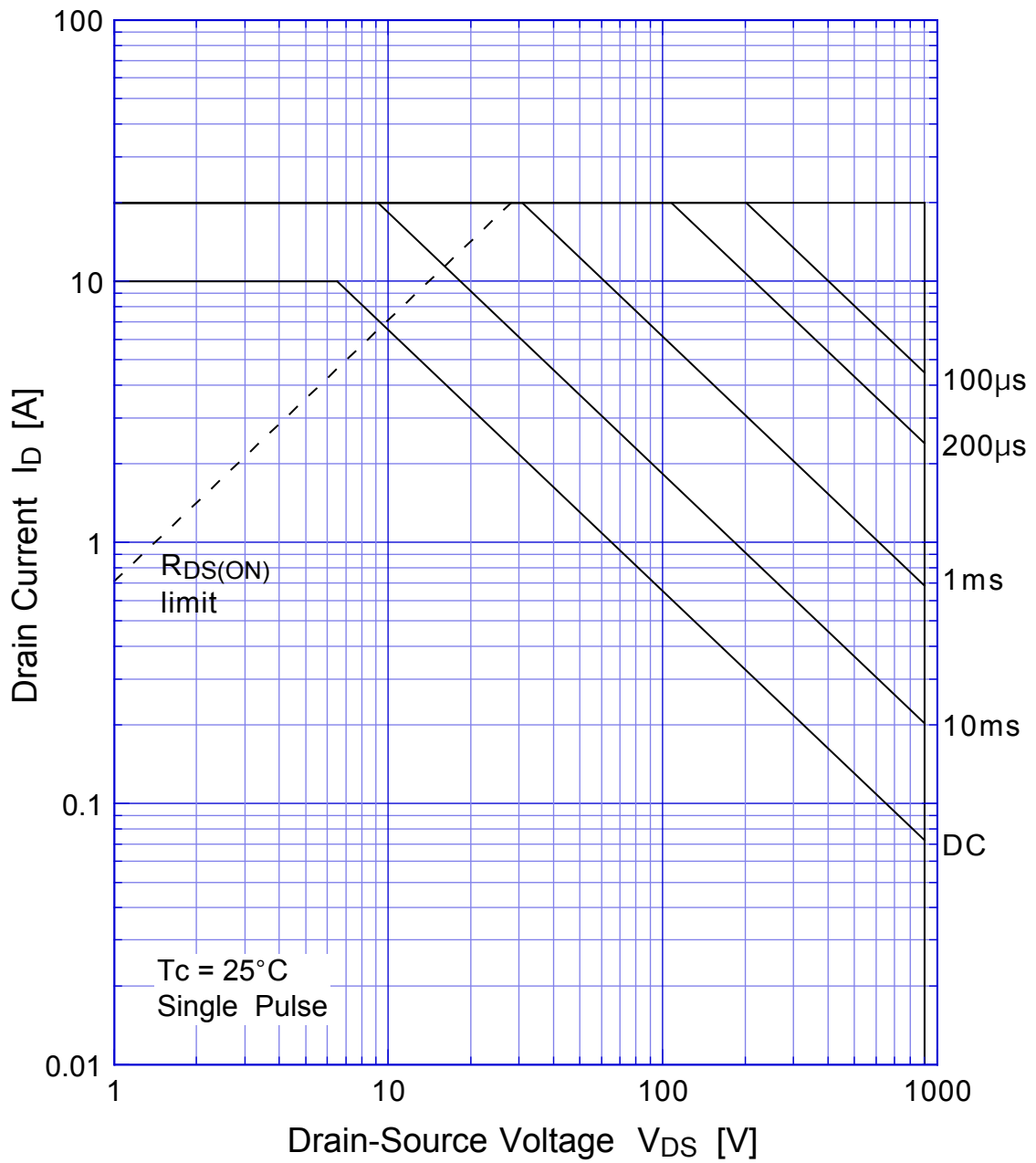

2SK2677 Transient Thermal Impedance

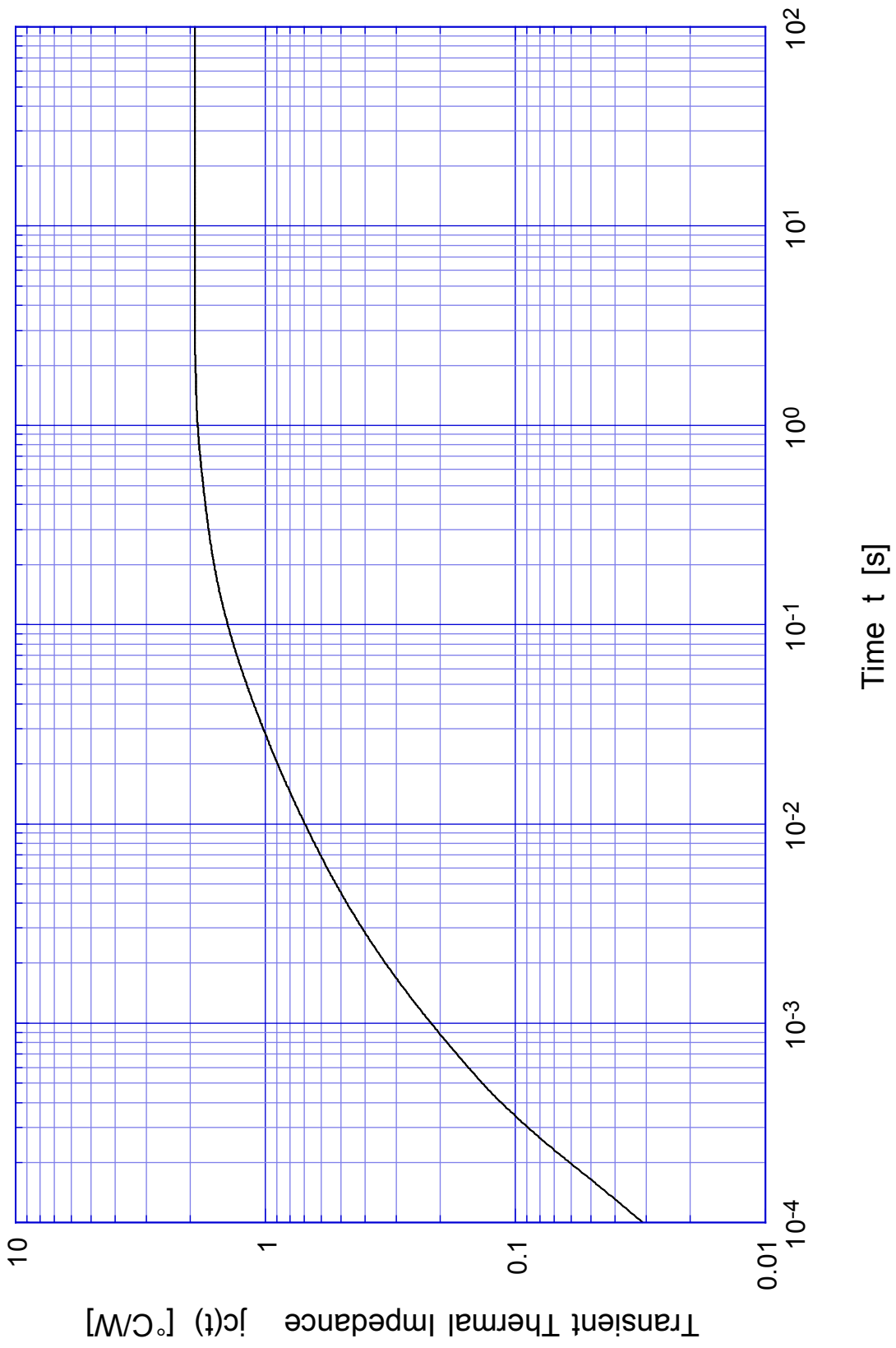

2SK2677 Single Avalanche Energy Derating



2SK2677 Capacitance

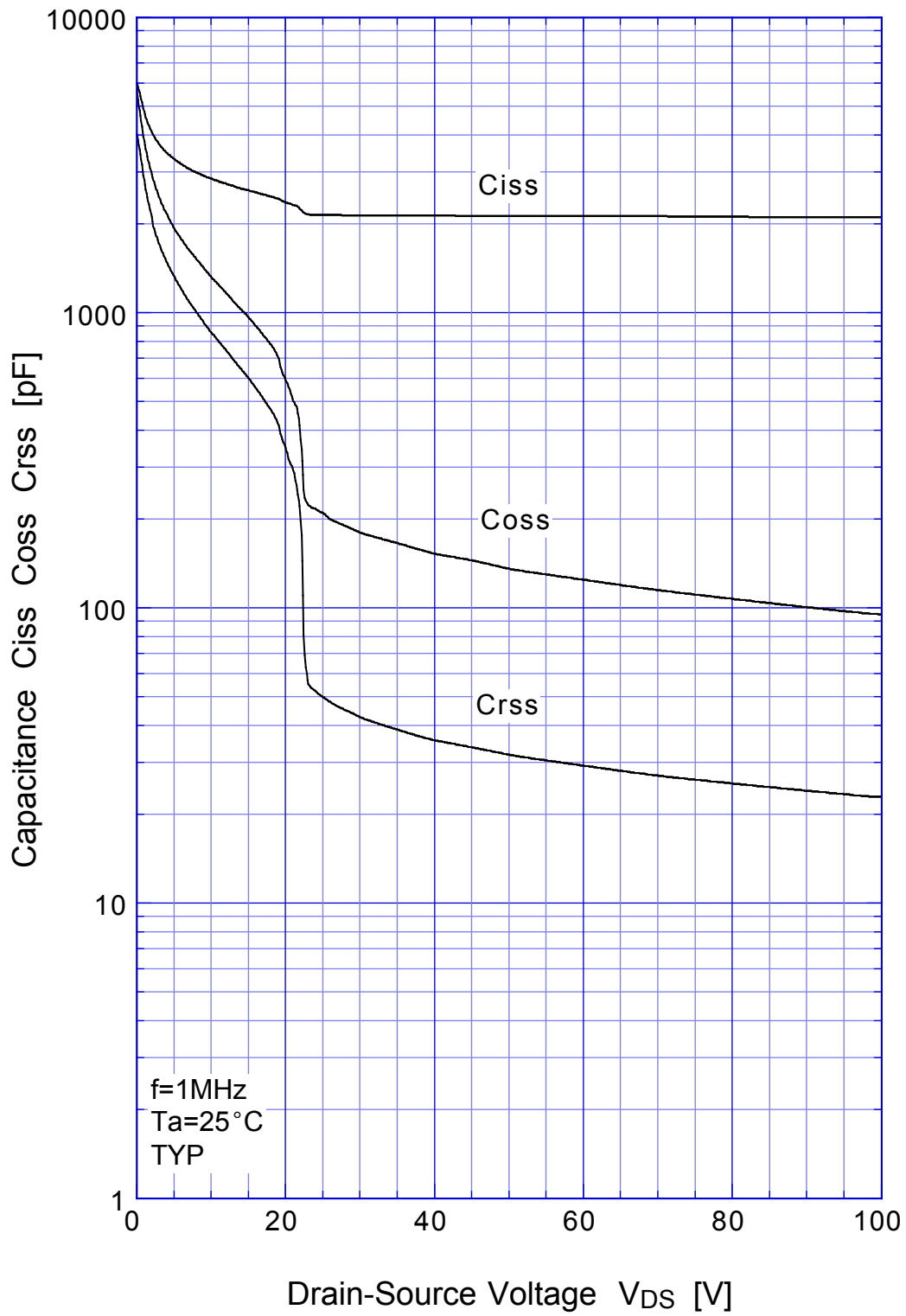

2SK2677

Single Avalanche Current - Inductive Load

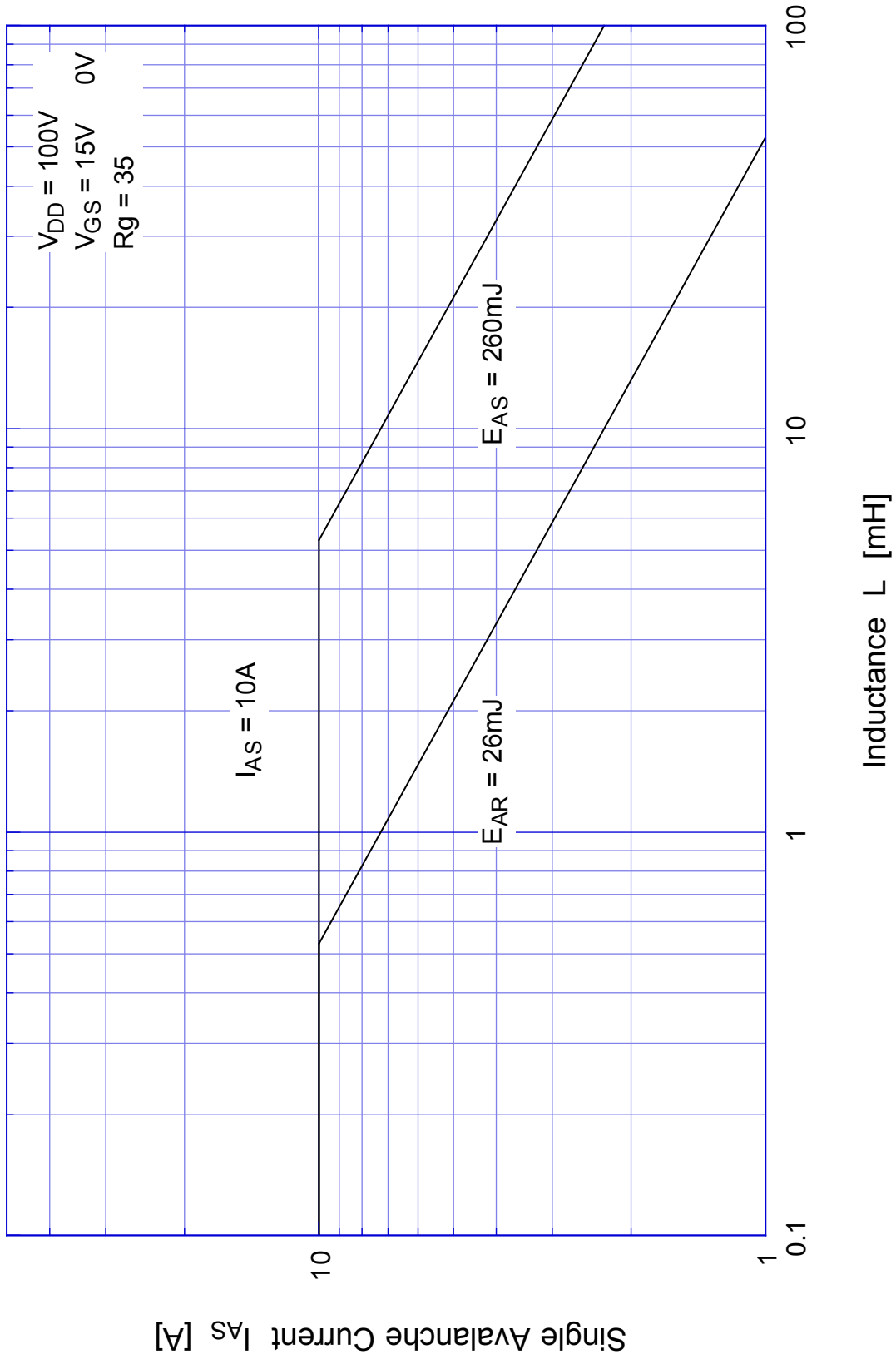

2SK2677

Power Derating



2SK2677 Gate Charge Characteristics

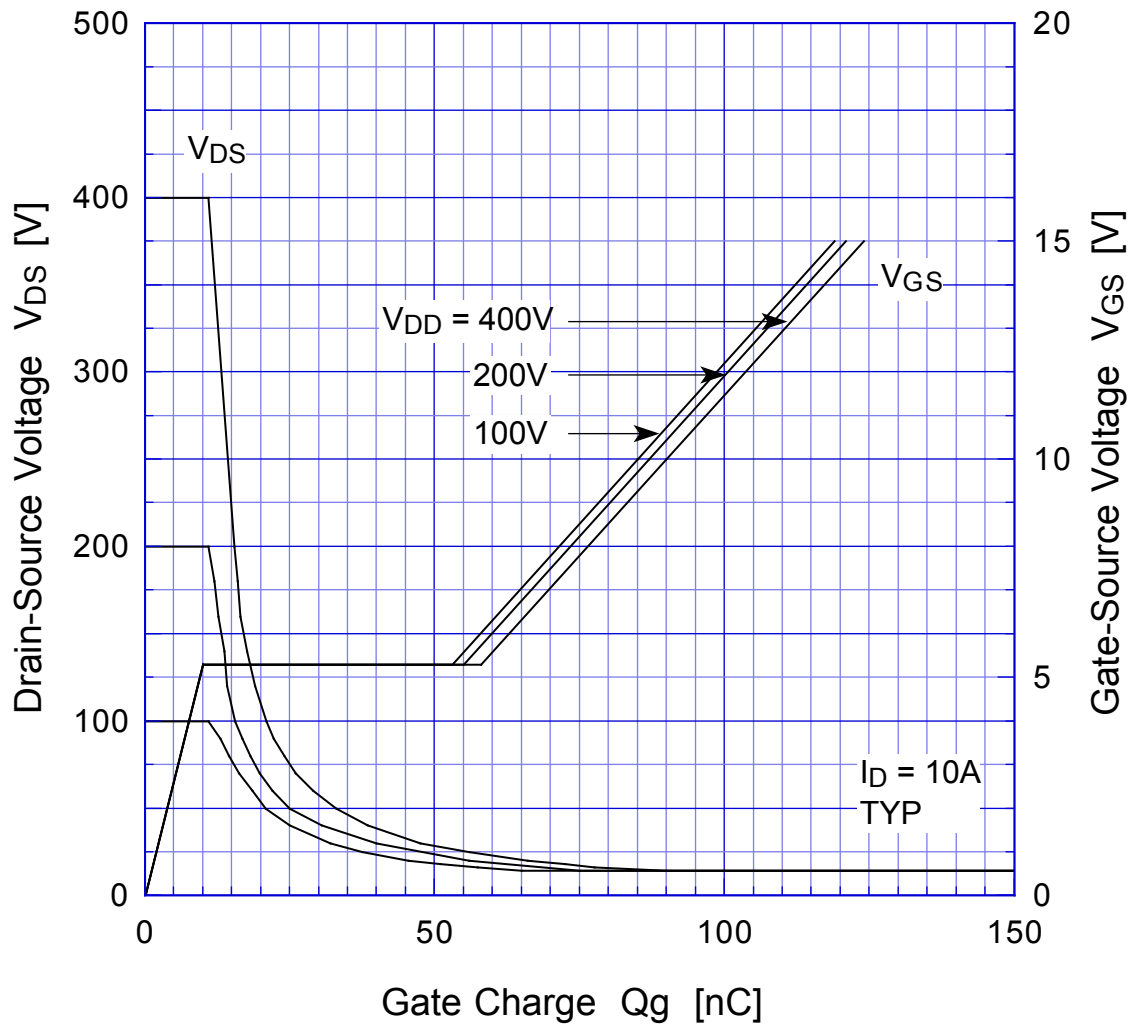

This datasheet has been download from:

www.datasheetcatalog.com

Datasheets for electronics components.