

KM2520SGC09

SUPER BRIGHT GREEN

Features

- SUBMINIATURE PACKAGE.
- WIDE VIEWING ANGLE.
- Z-BEND LEAD.
- LONG LIFE - SOLID STATE RELIABILITY.
- LOW PACKAGE PROFILE.
- PACKAGE : 1000PCS / REEL.
- RoHS COMPLIANT.

Description

The Super Bright Green source color devices are made with Gallium Phosphide Green Light Emitting Diode.

Package Dimensions

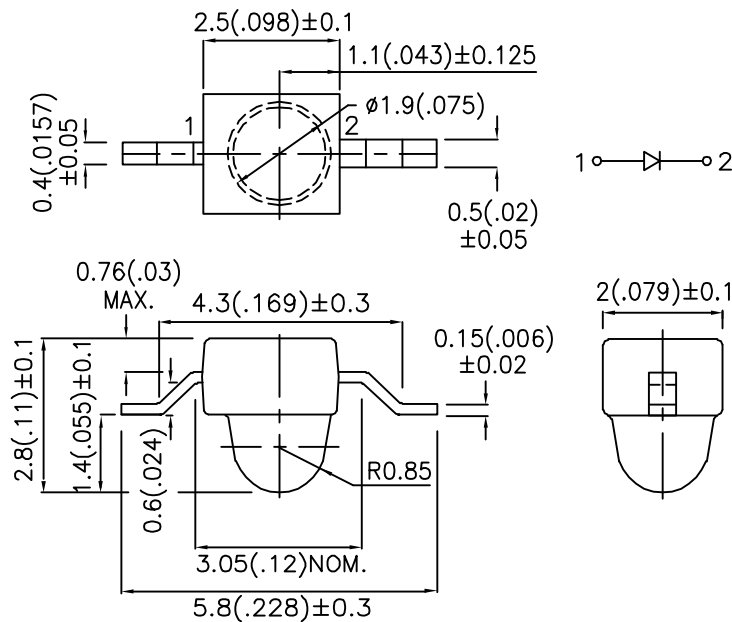

Notes:

1. All dimensions are in millimeters (inches).
2. Tolerance is $\pm 0.25(0.01)$ unless otherwise noted.
3. Lead spacing is measured where the leads emerge from the package.
4. Specifications are subject to change without notice.

Selection Guide

Part No.	Dice	Lens Type	Iv (mcd) @ 20mA		Viewing Angle
			Min.	Typ.	2 θ 1/2
KM2520SGC09	SUPER BRIGHT GREEN (GaP)	WATER CLEAR	36	80	20°

Note:

1. θ1/2 is the angle from optical centerline where the luminous intensity is 1/2 the optical centerline value.

Electrical / Optical Characteristics at TA=25°C

Symbol	Parameter	Device	Typ.	Max.	Units	Test Conditions
λpeak	Peak Wavelength	Super Bright Green	565		nm	IF=20mA
λD	Dominant Wavelength	Super Bright Green	568		nm	IF=20mA
Δλ1/2	Spectral Line Half-width	Super Bright Green	30		nm	IF=20mA
C	Capacitance	Super Bright Green	15		pF	VF=0V;f=1MHz
VF	Forward Voltage	Super Bright Green	2.2	2.5	V	IF=20mA
IR	Reverse Current	Super Bright Green		10	uA	VR = 5V

Absolute Maximum Ratings at TA=25°C

Parameter	Super Bright Green	Units
Power dissipation	105	mW
DC Forward Current	25	mA
Peak Forward Current [1]	140	mA
Reverse Voltage	5	V
Operating/Storage Temperature	-40°C To +85°C	

Note:

1. 1/10 Duty Cycle, 0.1ms Pulse Width.

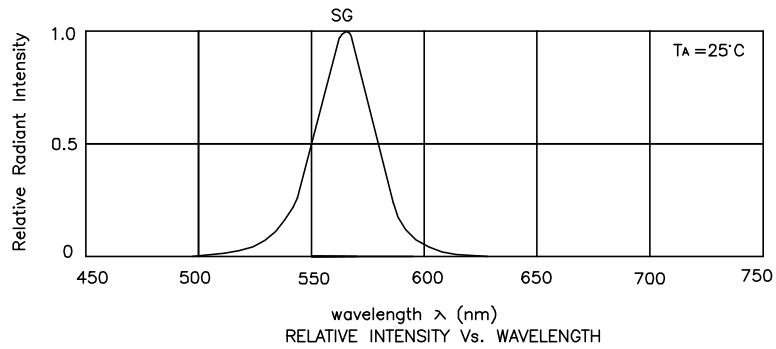

Super Bright Green

KM2520SGC09

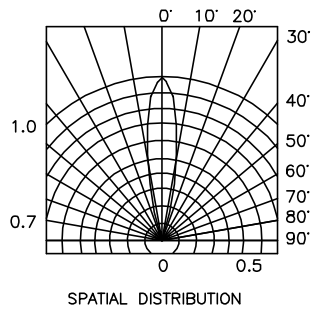
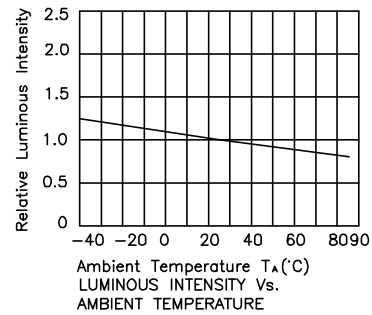
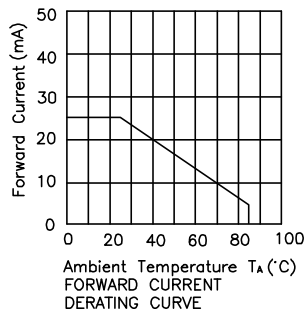
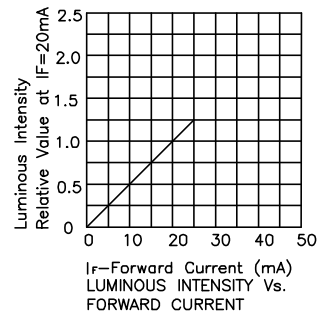
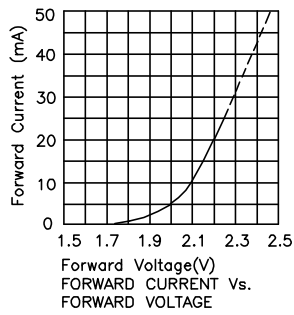

KM2520SGC09

Reflow Soldering Profile For Lead-free SMT Process.

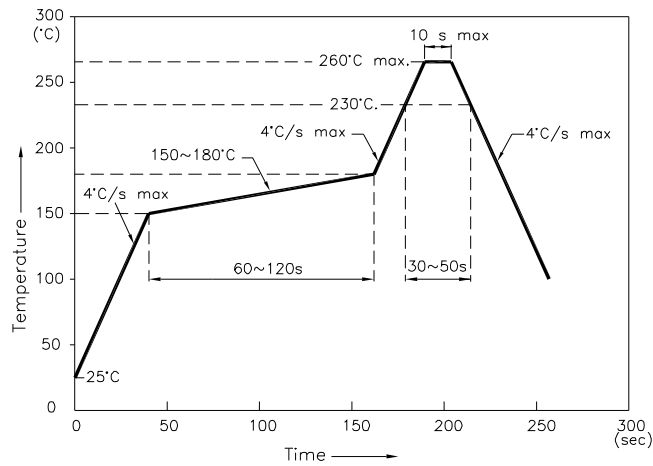

NOTES:

1. We recommend the reflow temperature 245°C(+/-5°C). The maximum soldering temperature should be limited to 260°C.
2. Don't cause stress to the epoxy resin while it is exposed to high temperature.
3. Number of reflow process shall be 2 times or less.

Recommended Soldering Pattern (Units : mm)

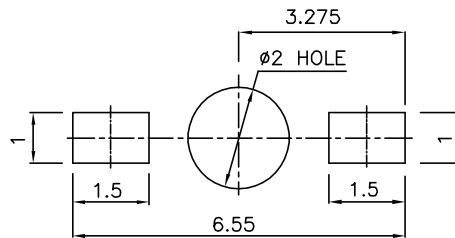

Tape Specifications (Units : mm)

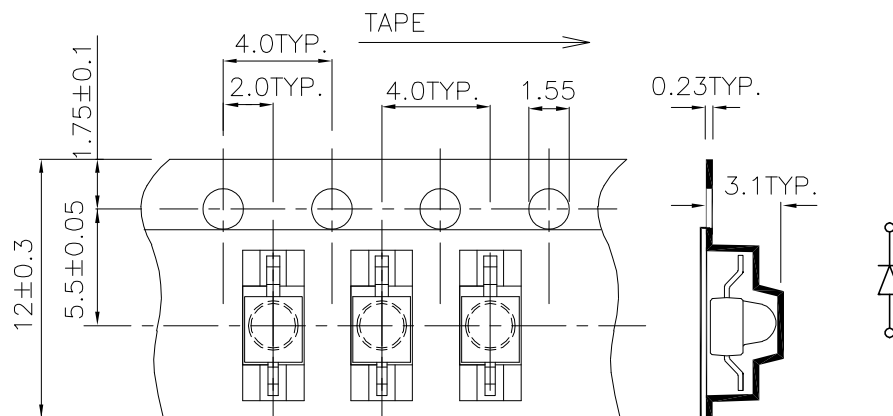

Remarks:

If special sorting is required (e.g. binning based on forward voltage, luminous intensity, or wavelength), the typical accuracy of the sorting process is as follows:

1. Wavelength: +/-1nm
2. Luminous Intensity: +/-15%
3. Forward Voltage: +/-0.1V

Note: Accuracy may depend on the sorting parameters.