

PRODUCT SPECIFICATION

Model No.: FYLF-1860UW1C

Features:	
<ul style="list-style-type: none"> ■ Flux LED Type ■ Size (mm):Φ3*7.62*7.62 ■ Emitting Color:White ■ Lens Type:Water clear ■ Pb-free Reflow soldering application ■ RoHS Compliant 	

Applications:
<ul style="list-style-type: none"> ■ Indicators ■ Automotive application ■ Decorative lighting ■ Illuminations



CUSTOMER APPROVED SIGNATURES	APPROVED BY	CHECKED BY	PREPARED BY

NINGBO FORYARD OPTOELECTRONICS CO.,LTD

Add:NO.115 Qixin Road Ningbo Zhejiang China

Zip:315051

Tel: 0086-574-87933652 87927870 87922206

Fax: 0086-574-87927917

E-mail:Sales@foryard.com (General)

Http://www.foryard.com

Model No.: FYLF-1860UW1C

Mechanical Dimensions

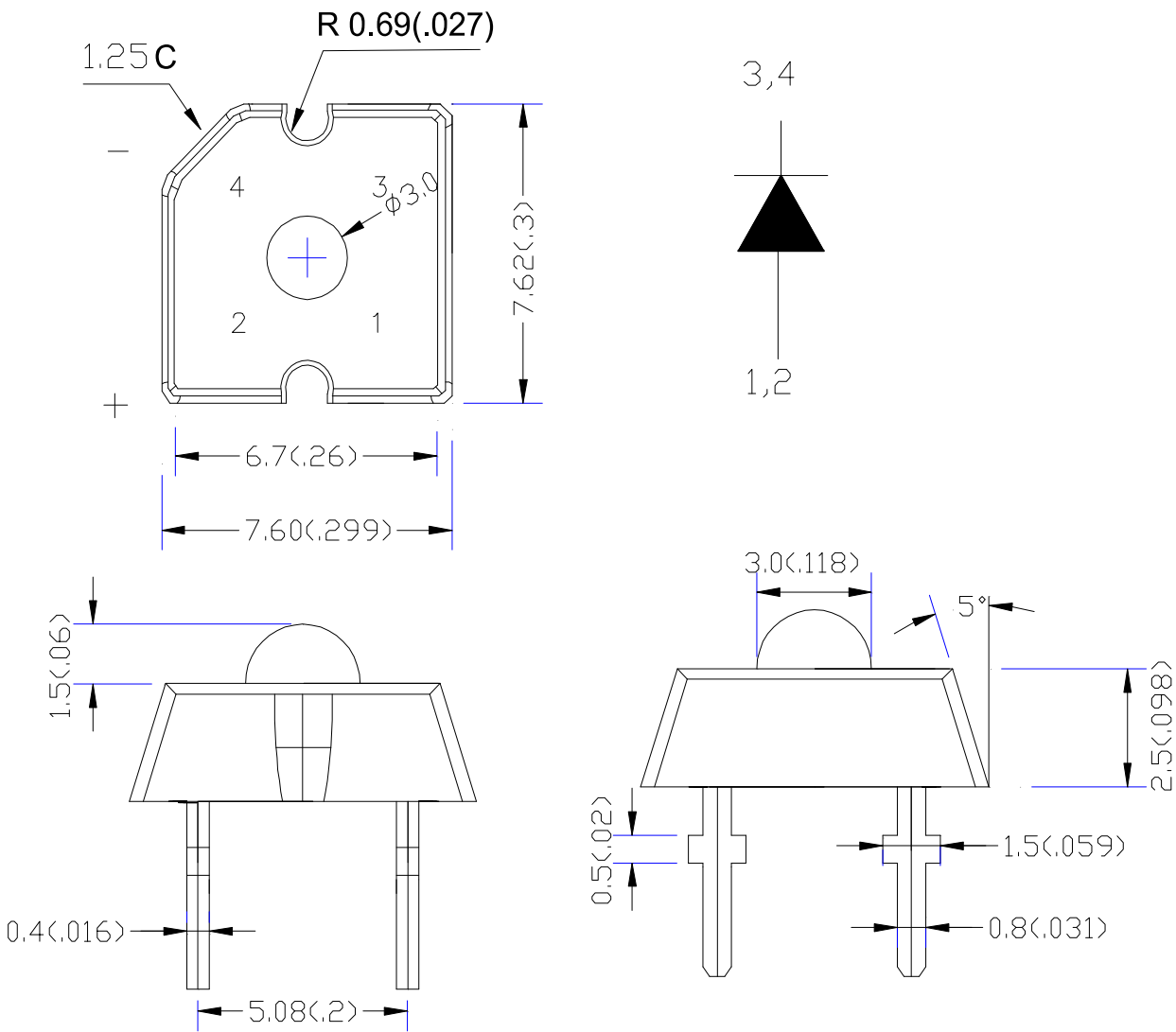

Notes:

1. Dimension in millimeter [inch], tolerance is ± 0.25 [.010] and angle is $\pm 1^\circ$ unless otherwise noted.
2. Bending \leq Length*1%.
3. The specifications, characteristics and technical data described in the datasheet are subject to change without prior notice.

Model No.: FYLF-1860UW1C

■ Absolute Maximum Ratings(Ta=25° C)

Items	Symbol	Absolute maximum Rating	Unit
Forward Current(DC)	IF	30	mA
Peak Forward Current*	IFP	100	mA
Power Dissipation	PD	120	Mw
Operation Temperature	Topr	-40° C+85° C	°C
Storage Temperature	Tstg	-40°C+100°C	°C
Reverse Voltage	VR	5	V
Soldering Temperature	Tsol	Reflow Soldering:260°C/3sec	

*Pulse width \leq 1msec duty \leq 1/10

■ Typical Electrical & Optical Characteristics(Ta=25°C)

Items	Symbol	Condition	Min.	Typ.	Max	Unit
Forward Voltage	VF	IF = 20mA	2.80	---	3.60	V
Reverse Current	IR	VR = 5V			5	uA
Chromatic Coordinates	(X, Y)	IF = 20mA	---	(0.29,0.30)	---	
Luminous Flux	Φ_V	IF = 20mA	---	6.0	---	LM
Luminous Intensity	IV	IF = 20mA	---	3500	---	mcd
50% Power Angle	2 $\theta_{1/2}$	IF = 20mA	---	90	---	Deg

■ Material

Item	Reflector	Wire	Encapsulate	Chip
Material	Copper	Gold	Epoxy	InGaN

Note:

- 1.Luminous Intensity is based on the Foryard standards.
- 2.Pay attention about static for InGaN

Model No.: FYLF-1860UW1C

Typical Electrical/Optical Characteristics Curves(Ta=25° C Unless Otherwise Noted)

Spectral Reduance

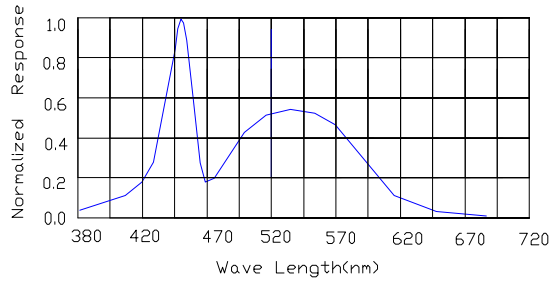

Forward Current Vs Forward Voltage

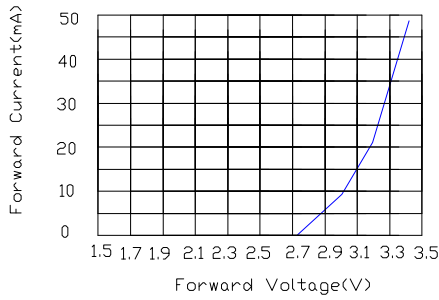

Relative Luminous intensity vs Forward current

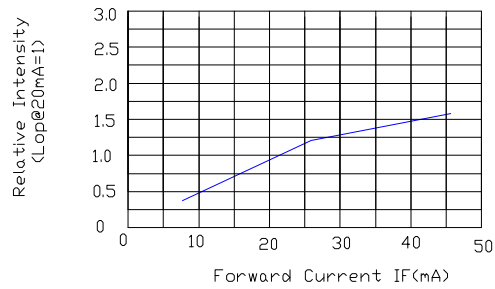

Forward Current Derating Curve

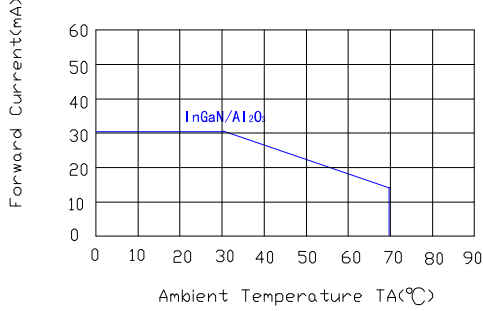

Luminous Intensity Vs. Ambient Temperature

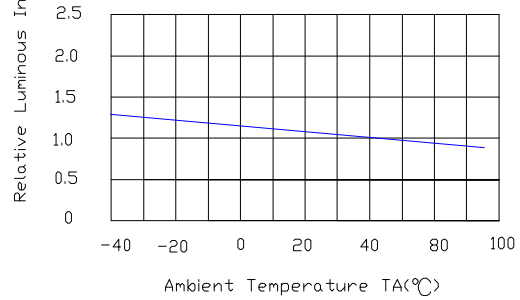

Radiation pattern.

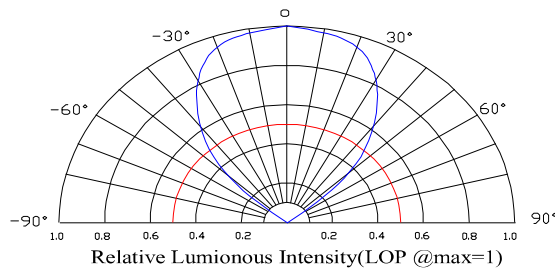

Model No.: FYLF-1860UW1C

■ Packing Diagram

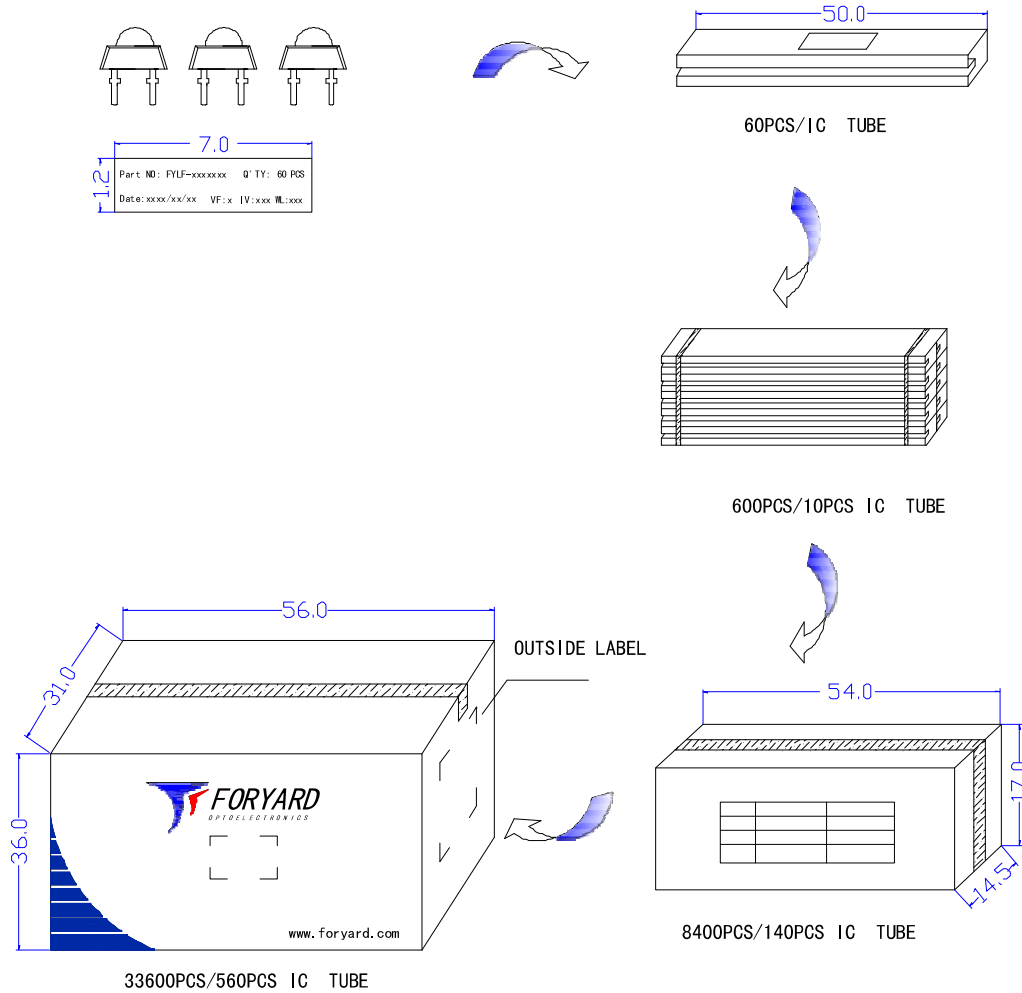

OUTSIDE LABEL

Model No.: FYLF-1860UW1C

■ **Precautions for use:**

1. Storage

Any mechanical force or any excess vibration shall not be accepted to apply during cooling process to normal temperature after soldering.

Avoid quick cooling.

Lead frames are silver plated copper alloy. The silver plate surface may be affected by environments which contains corrosive substances. Please avoid conditions which may cause the LEDs to corrode, tarnish or discolour.

2. Soldering

Manual Soldering		Solder Dipping	
Soldering Iron	35W max.	Preheat	110°C max
Temperature	280°C max(63/37 Solder)	Preheat time	60 seconds max.
	300°C max(Pb free solder)	Solder temperature	63/37 Solder:235°C(245°C max)
Soldering Time	3 seconds max.		Pb-free solder:255°C(260°C max)
Position	Not less than 3mm from the base of the epoxy	Dipping Time	3 seconds max.
		Position	Not less than 3mm from the base of the epoxy

Recommended soldering profile:

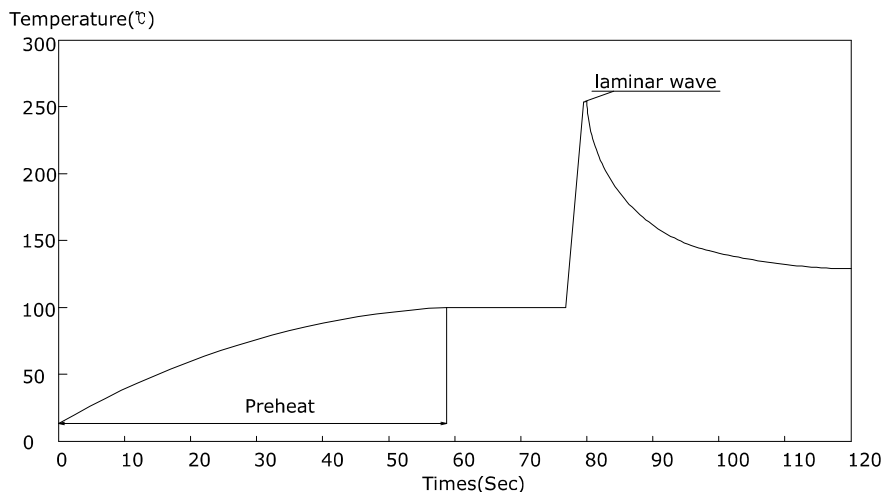

Solder=Sn 63-Pb 37	Solder= Pb-Free
Peak preheat temperature:100-110°C	Peak preheat temperature:100-110°C
Total preheat time:50-60seconds	Total preheat time:50-60seconds
Peak profile fit temperature:235°C(max 245°C)	Peak profile fit temperature:260°C max
well time above 200°C should not exceed 3 second	Dwell time above 200°C should not exceed 3 seconds

Model No.: FYLF-1860UW1C

Caution:

The LEDs must not be repositioned after soldering.
Do not apply any stress to the lead particularly when heat.

3. Static Electricity

Static Electricity and surge voltage damage the LEDs. So it is recommended that an ESD wrist band, ESD shoe strap or an anti-electrostatic glove be used when handling the LEDs.
All devices, equipment and machinery must be properly grounded.

4. Others

Reverse voltage should not exceed the absolute maximum rating on the data sheet.
The LED leads may become tarnished if they contact hydrogen sulphide or other gaseous chemicals.
The colour of the LEDs is changed slightly an operating current and thermal.
This device should not be used in any type of fluid such as water, oil, organic solvent and etc.
When washing is required, IPA (Isopropyl Alcohol) should be used.
The influence of ultrasonic cleaning on the leds depends on factors such as ultrasonic power and the way.
Gallium arsenide is used in some of the products listed in this publication. These products are dangerous if they are burned or smashed in the process of disposal, It is also dangerous to drink the liquid or inhale th generated by such products when chemically disposed.
High-brightness LED light may injure human eyes. Avoid looking directly into lighted LED.
The appearance and specifications of the product may be modified for improvement without notice.