

Precision Devices, Inc.

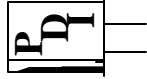

8840 N. Greenview Dr.
 Middleton, WI 53562
 Phone: 608-831-4445
 1-800-274-XTAL
 Fax: 608-831-3343

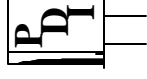

Visit our web site at www.pdixtal.com

Sales Information sales@pdixtal.com

Electrical Specifications

1. Center Frequency: 25.000000MHZ
2. Output: LVPECL
3. Frequency Stability: ± 50 ppm All Inclusive (Including 10 year Aging)
4. Operating Temperature Range: 0°C to +70°C
5. Storage Temperature Range: -55°C to +125°C
6. Input Voltage: +3.3Vdc $\pm 10\%$
7. Input Current: 88mA Maximum
8. Duty Cycle: 45/55% Maximum @ Vcc -1.3V
9. Load: 50 Ohms to Vcc-2Vdc
10. T-Rise, T-Fall: 0.5nSec Maximum from 20%/80% of Output Voltage Swing
11. Logic Levels:
 - "1" Level: Vcc-1.02V Min.
 - "0" Level: Vcc-1.63V Max.
12. Output Voltage Swing: 0.61Vpp Minimum
0.90Vpp Maximum
13. Cycle to Cycle Jitter: 3pS Maximum
14. Phase Jitter: 1.5pS Maximum (12Khz to 20Mhz)
15. Peak to Peak Jitter: 20pS Maximum
16. Enable/Disable Pin1 function with internal pull-up:
 - signal out =0.75xVcc or open
 - No signal = 0.20xVcc or ground

NOTE

1. This part shall not contain any lead products.

The information contained in this drawing is the sole property of Precision Devices Inc. Any reproduction in part or as a whole without the written permission of Precision Devices Inc. is prohibited.

REV.	DATE	PAGE	DESCRIPTION	Auth.	ECN	FOR PRELIMINARY USE ONLY Specifications subject to change without notice.	
						TITLE	FKA
						Ceramic Crystal Oscillator Assembly 6316	
						PART NUMBER PE0725000XECAXX	
				DATE	SCALE	ECN.	REV.
				3/9/07	N.T.S.	N/A	N/A
				SIZE	CAGE	Page 1 of 2	
				A	OS4G1		

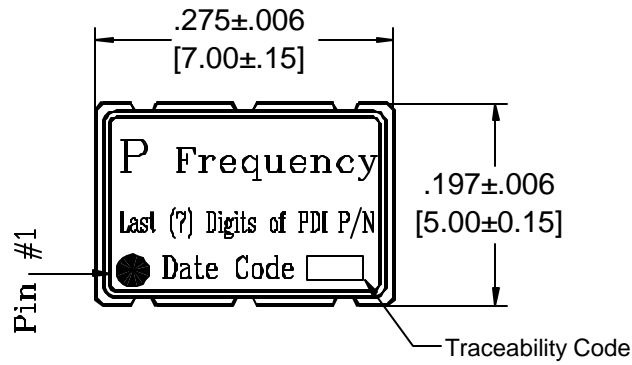

PIN	CONNECTION
1	Enable/Disable
2	N/C
3	GND
4	VC D+
5	VC D-
6	Vcc

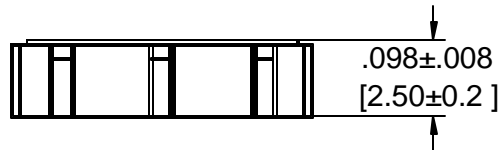

Recommended Land Pattern

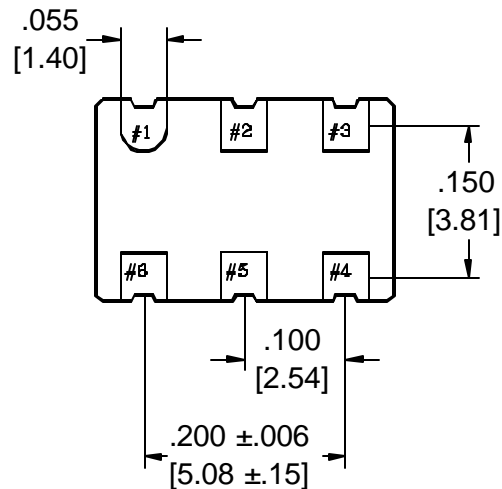
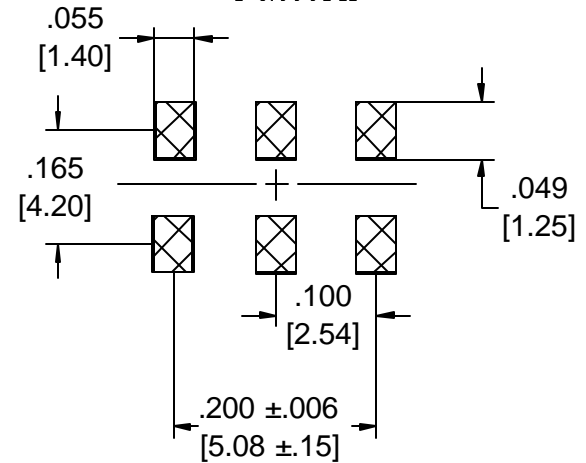

Precision Devices Inc.

8840 N. Greenview Dr.
Middleton WI 53562
608-831-4445
1-800-274-XTAL

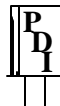

Manufacturer of Quartz Crystal Products

DECIMAL XX=±.020 XXX=±.008	DWG FILE 6316	PART NUMBER PE0725000XECAXX	
METRIC XX=±.50 XXX=±.20	SCALE N.T.S.	FREQUENCY 25.000000 MHz	DRAWN BY J.Lawinger
ANGULAR XX=±2°	REV. LEVEL N/A	ECN NO. N/A	DATE 3/9/07
		CAGE CODE OS4G1	Page 2 of 2