

SAW Resonator R31451



Features

- 1-port Resonator
- Quartz Frequency Stabilization
- For transmitters or Local Oscillators

Package Dimension – S5050

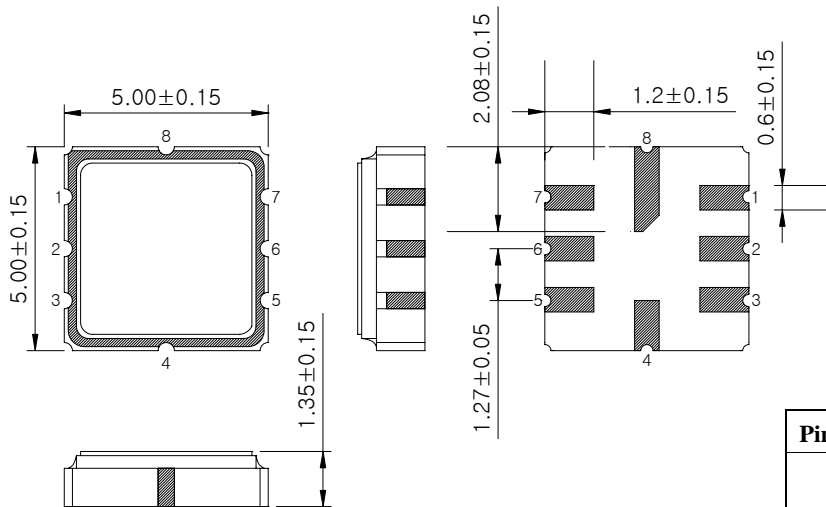

Pin Configuration	
2	Input
6	Output
1, 3, 4, 5, 7, 8	Ground

Package Dimension – TO-39

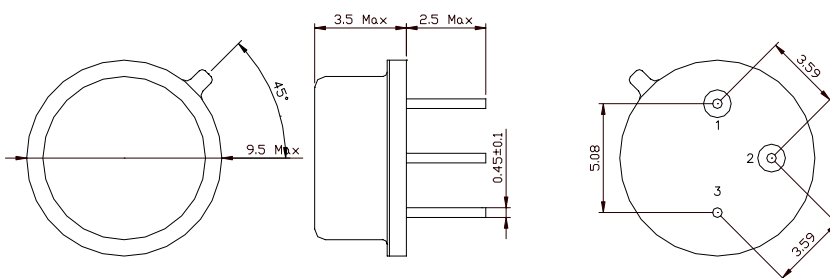

Pin Configuration	
1	Input
2	Output
3	Case ground

	ITF Co., Ltd. 102-901, Bucheon Technopark 364, Samjeong-Dong, Ojeong-Gu, Bucheon-City, Gyeonggi-Do, Korea 421-809	Part No.	R31451	
		Rev. Date	2004-04-20	
		Rev.	NS3108-AS01	1/6

SAW Resonator R31451



Package Dimension – F-11

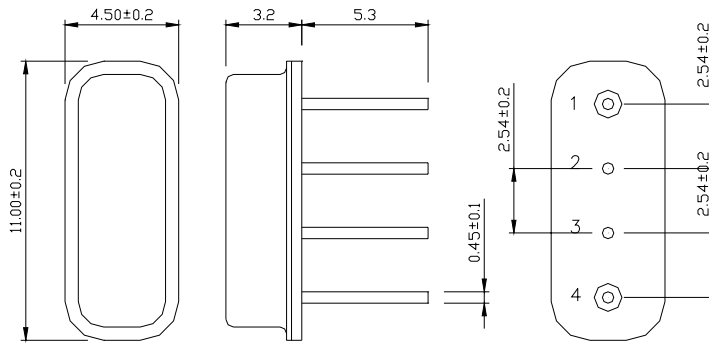

Pin Configuration	
1	Input
4	Output
2, 3	Case ground

Marking Configuration

ITF¹⁾
31451²⁾

- 1) Manufacturer name
- 2) Marking Number
- * Ink or Laser Marking available
- * Front 4 digits for S5050

Maximum Ratings

Parameter	Unit	Minimum	Typical	Maximum
Operating Temperature Range	°C	-10	25	60
Storage Temperature Range	°C	-40	-	85
Power Handling Capability	dBm	-	0	-

Electrostatics Sensitive Device (ESD)

	ITF Co., Ltd. 102-901, Bucheon Technopark 364, Samjeong-Dong, Ojeong-Gu, Bucheon-City, Gyeonggi-Do, Korea 421-809	Part No.	R31451	
		Rev. Date	2004-04-20	
		Rev.	NS3108-AS01	2/6

SAW Resonator R31451



Electrical Specification

$F_R = 314.5\text{MHz}$

Terminating source impedance : 50Ω and matching network

Terminating load impedance : 50Ω and matching network

		Minimum	Typical	Maximum
Resonance Frequency (F_R)	MHz	314.425	314.500	314.575
Insertion Loss	dB	-	1.5	2.5
50 ohm Loaded Q			2,000	
Unloaded Q			13,900	
Trun-over Temperature	$^{\circ}\text{C}$	10	25	40
Temperature Coefficient of Frequency	$\text{ppm}/^{\circ}\text{C}^2$	-	-0.032	-

Notes :

- 1) All specifications are based on the matching schematic shown below
- 2) All specifications are measured by Agilent Network analyzer and full 2 port calibration at room temperature

Matching Schematic

(Actual matching values may vary due to PCB layout and parasitics)

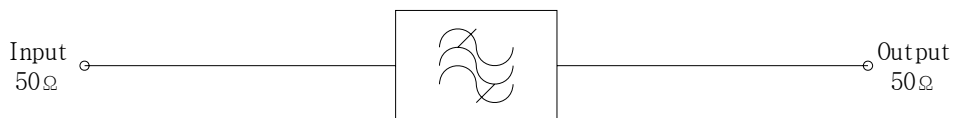



	ITF Co., Ltd. 102-901, Bucheon Technopark 364, Samjeong-Dong, Ojeong-Gu, Bucheon-City, Gyeonggi-Do, Korea 421-809	Part No.	R31451	
		Rev. Date	2004-04-20	
		Rev.	NS3108-AS01	3/6

SAW Resonator R31451

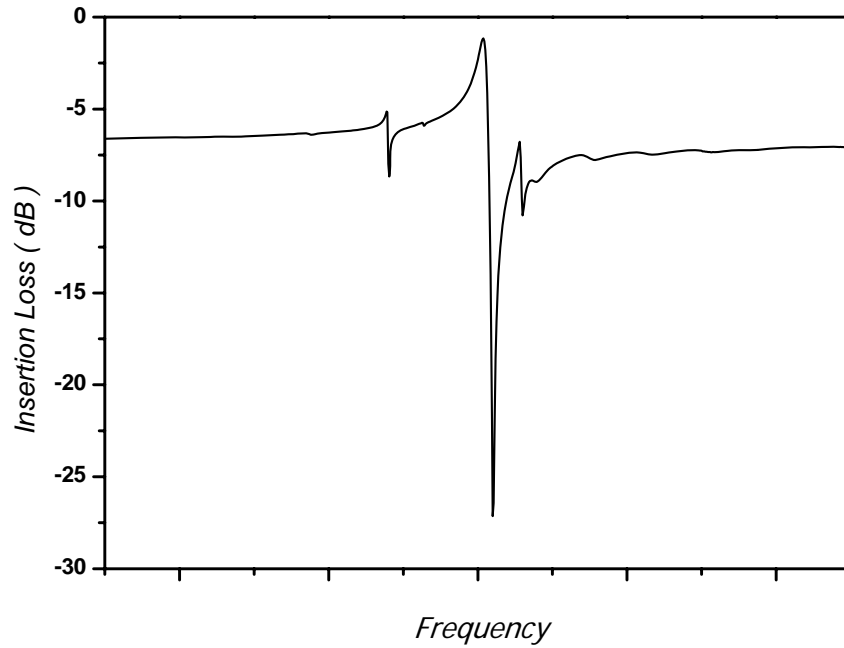

Frequency Response



 Integrated Technology Future	ITF Co., Ltd. 102-901, Bucheon Technopark 364, Samjeong-Dong, Ojeong-Gu, Bucheon-City, Gyeonggi-Do, Korea 421-809	Part No.	R31451	
		Rev. Date	2004-04-20	
		Rev.	NS3108-AS01	4/6

SAW Resonator R31451



Packing Specification

1. Reeling Quantity : 1000 pcs / reel
2. Taping Structure : The tape shall be wound around the reel in the direction shown below.

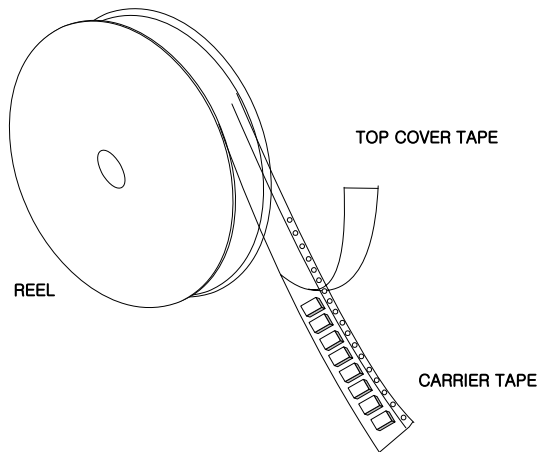

Tape Specification

1. Leader part and vacant position specification

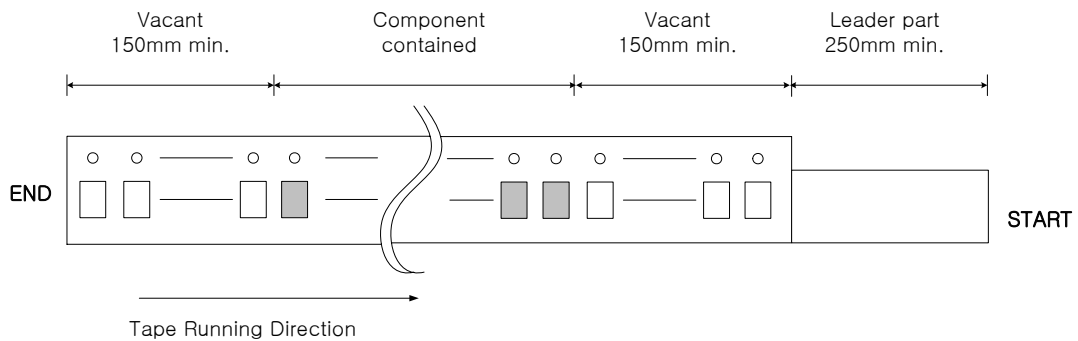

2. Tensile strength of carrier tape

4.4N/mm width

3. Top cover tape adhesion

- 1) pull off angle : 0~15°
- 2) speed : 300mm/min
- 3) force : 20~70g

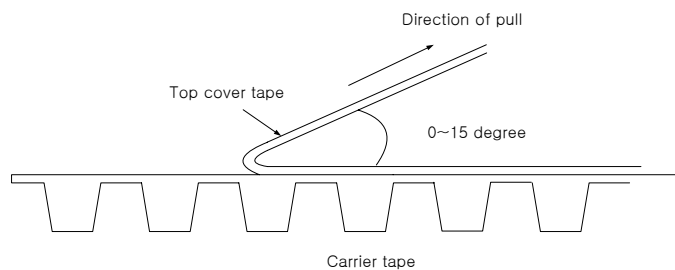

	ITF Co., Ltd. 102-901, Bucheon Technopark 364, Samjeong-Dong, Ojeong-Gu, Bucheon-City, Gyeonggi-Do, Korea 421-809	Part No.	R31451	
		Rev. Date	2004-04-20	
		Rev.	NS3108-AS01	5/6

SAW Resonator R31451



Carrier Tape Dimensions [unit : mm]

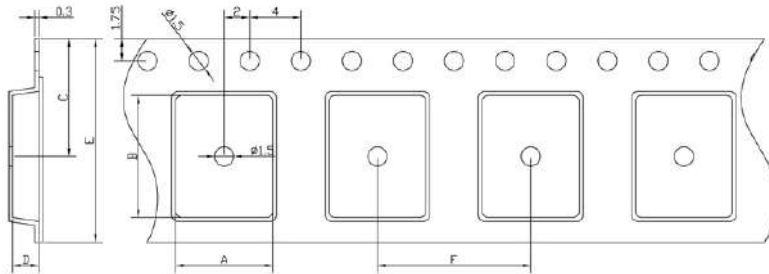

A	5.50 ± 0.1
B	5.50 ± 0.1
C	7.25 ± 0.1
D	1.95 ± 0.1
E	12.00 ± 0.1
F	8.00 ± 0.1

Part Direction

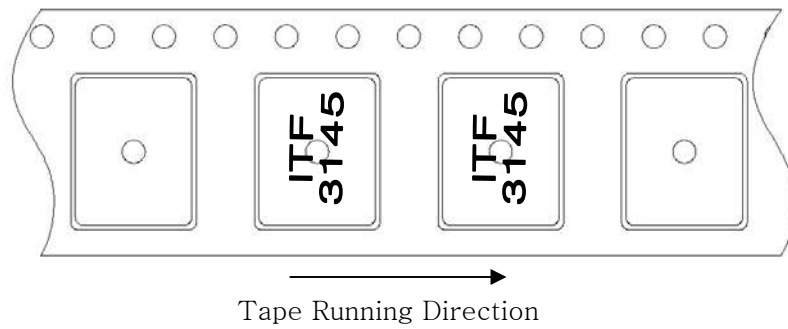

Reel Dimensions [unit : mm]

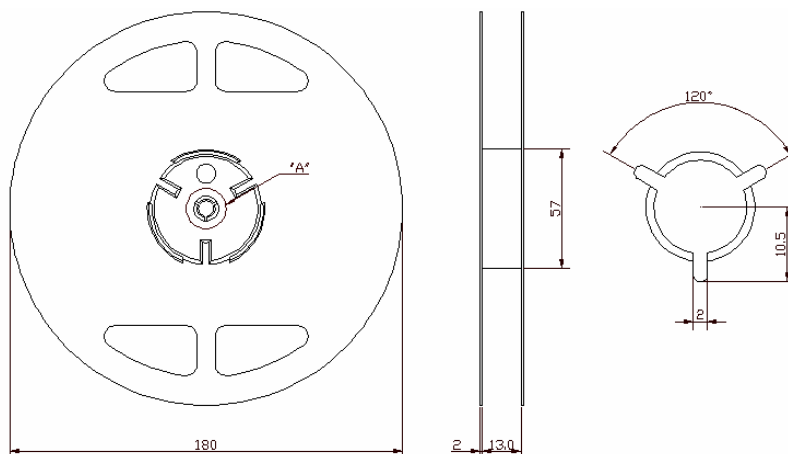

	ITF Co., Ltd. 102-901, Bucheon Technopark 364, Samjeong-Dong, Ojeong-Gu, Bucheon-City, Gyeonggi-Do, Korea 421-809	Part No.	R31451	
		Rev. Date	2004-04-20	
		Rev.	NS3108-AS01	6/6