

SPECIFICATION

FOR APPRONAL

Customer : _____

Product Name : Dynamic Speaker _____

Model Name : VS3051R8F550P1C80 _____

Drawing No. : VS20210928012 _____

Signature of Voise

Approved by	Checkde by	Issued by	Date

 福爱斯电子有限公司
VOISE ELECTRONICS CO.,LTD.

Address:No 96 Mogao Dongqian Lake Industial Area ningbo,China,
Tel:0086-0574-87773030;Fax:0086-0574-87471600 P.C.315121
<http://www.nbvoise.com> Email:sales@nbvoise.com

Specification for Dynamic Speaker		Page	3/8
		Revision No.	1.1
Model No.:	VS3051R8F550P1C80	Drawing No.	VS20210928012

2. Scope

This document contains required environmental, electrical, acoustic, mechanical, package and reliability test requirement

3. General Characteristics

- 2.1 Out-Diameter : 30 mm
- 2.2 Height : 5.8 mm
- 2.3 Weight : 6.5 g
- 2.4 Operating Temperature : -30~+70°C without loss of function
- 2.5 Store Temperature : -40~+85°C without loss of function

4. Electrical and Acoustic Characteristics.

Test condition : 15 ~ 35 °C Temp., 25% ~ 75% RH, 86~106 kPa Refer to IEC60268-1

No	Items	Specification
1	Impedance	8 Ω ± 15% (1Vrms at 1.2KHz)
2	Sound Pressure Level	92 dB ± 3dB (0.1m/0.1w at 0.8,1.0,1.2,1.5kHz Average)
3	Resonance Frequency(fo)	550 Hz ± 20% at 1V
4	Frequency Range	fo ~20KHz
5	Input Power	Rated 1 W / Max. 2 W for one minute
6	Distortion	Less than 5% at 1kHz 1.0W
7	Buzz and Rattle	Should not be audible buzzes,rattles when the 2.83V sine wave signal swept at frequency range.
8	Polarity	When a positive DC current is applied to the voice coil terminal marked (+) , the diaphragm shall move to forward.
9	Waterproof grade	IP54

Specification for Dynamic Speaker		Page	4/8
		Revision No.	1.1
Model No.:	VS3051R8F550P1C80	Drawing No.	VS20210928012

5. Reliability Test

After test(1~7item), the speaker S.P.L . difference shall be within $\pm 3\text{dB}$, and the appearance not exist any change to be harmful to normal operation

No	Items	Specification
1	High Temp.Test	Keep 100 hours at $+70\pm 3\text{ }^{\circ}\text{C}$,and leave 3 houres in normal temperature and then check.
2	Low Temp.Test	Keep 100 hours at $-30\pm 3\text{ }^{\circ}\text{C}$,and leave 3 houres in normal temperature and then check.
3	Humidity Test	Keep 100 hours at $-30\pm 3\text{ }^{\circ}\text{C}$,relative humidity 85 to 90% and leave 4 houres in normal temperature and then check.
4	Thermal Shock Test	Each temperature cycle shall consist of 2 hours at $+25\pm 3\text{ }^{\circ}\text{C}$ followed by 2hours at $+60\pm 3\text{ }^{\circ}\text{C}$,and followed by 2hours at $-30\pm 3\text{ }^{\circ}\text{C}$ with a 20 to 40 minutes transition time between each 2 temperature extremes. The test duration is for 10 cycle.
5	Vibration Test	Being applied vibration of amplitude of 1.5mm with 10-55-10Hz band of vibration frequency,X.Y.Z.3 direction.2 hours each, total 6 hours.
6	Drop Test	Free drop fram 1.0 meter height to a board 20mm thick hard wood board. and be nothing mechanical damage. tatol 6 times.
7	Load test	Loading white noise with input rate power for 100 hours, then placed in natural condition for 1 hour and then check.
8	Insulation test	When they are measured with DC 100V the insulation resistance between v.c. terminal and frame must be more than 1 M Ω

Specification for Dynamic Speaker		Page	5/8
		Revision No.	1.1
Model No.:	VS3051R8F550P1C80	Drawing No.	VS20210928012

6. Measurement Method & Frequency Response curve

Standard test condition of speaker

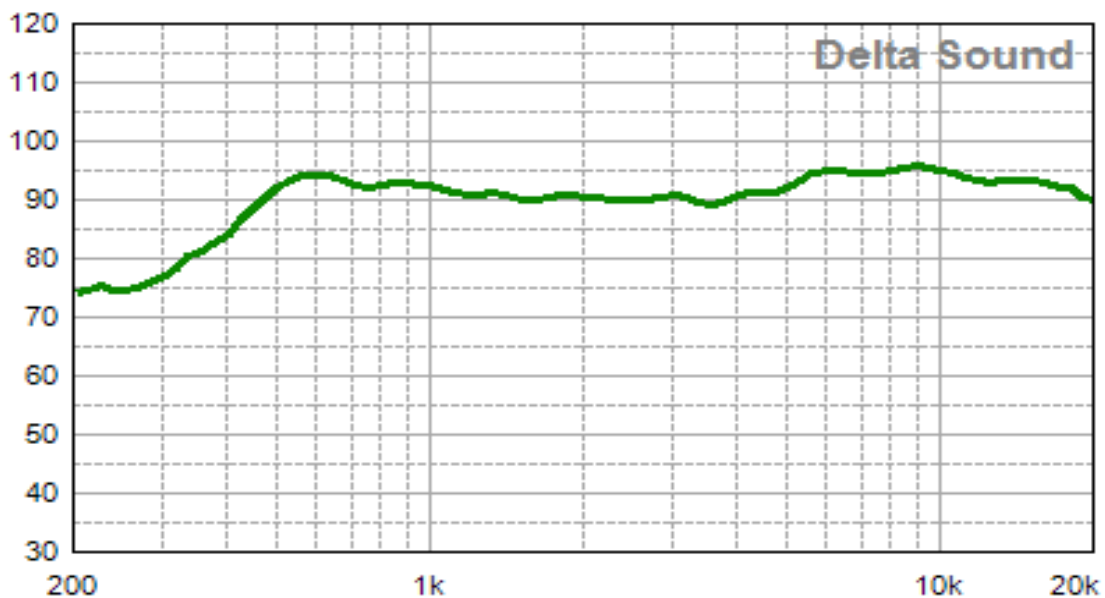
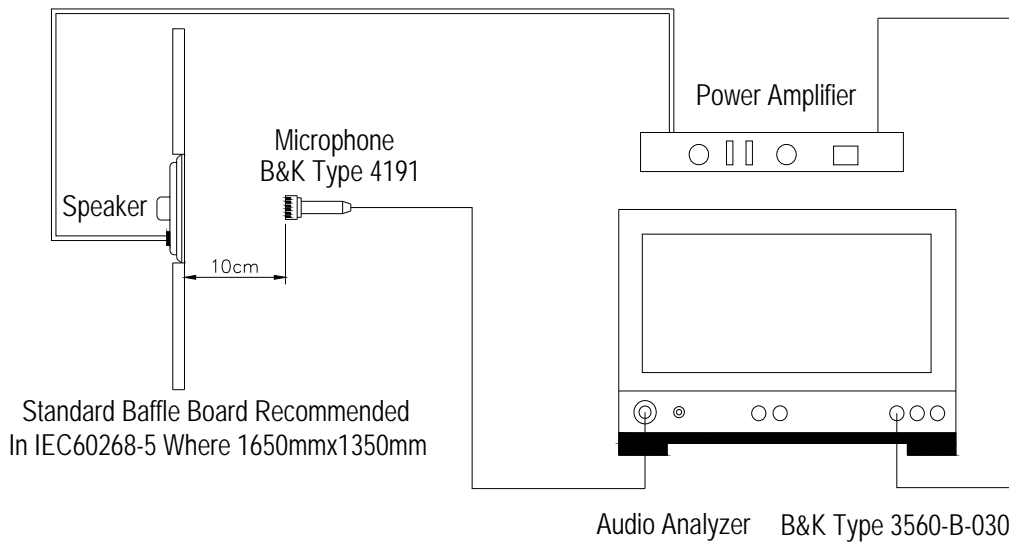

Specification for Dynamic Speaker		Page	6/8
		Revision No.	1.1
Model No.:	VS3051R8F550P1C80	Drawing No.	VS20210928012

7. Mechanical layout

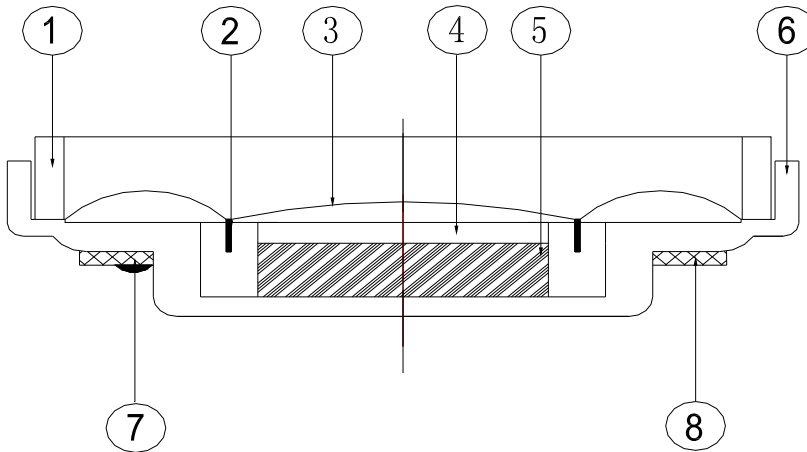

No.	Part Name	Q'ty	Material	Remarks
8	Screen	1	Unwoven fabric	
7	PCB	1	FR-4	
6	Frame	1	SPCC	
5	Magnet	1	Nd-Fe-B	
4	Plate	1	SPCC	
3	Diaphragm	1	PEN	
2	Voice coil	1	Bobbin Copper	
1	Gasket	1	Plastic	

Specification for Dynamic Speaker		Page	7/8
		Revision No.	1.1
Model No.:	VS3051R8F550P1C80	Drawing No.	VS20210928012

8. Dimensions

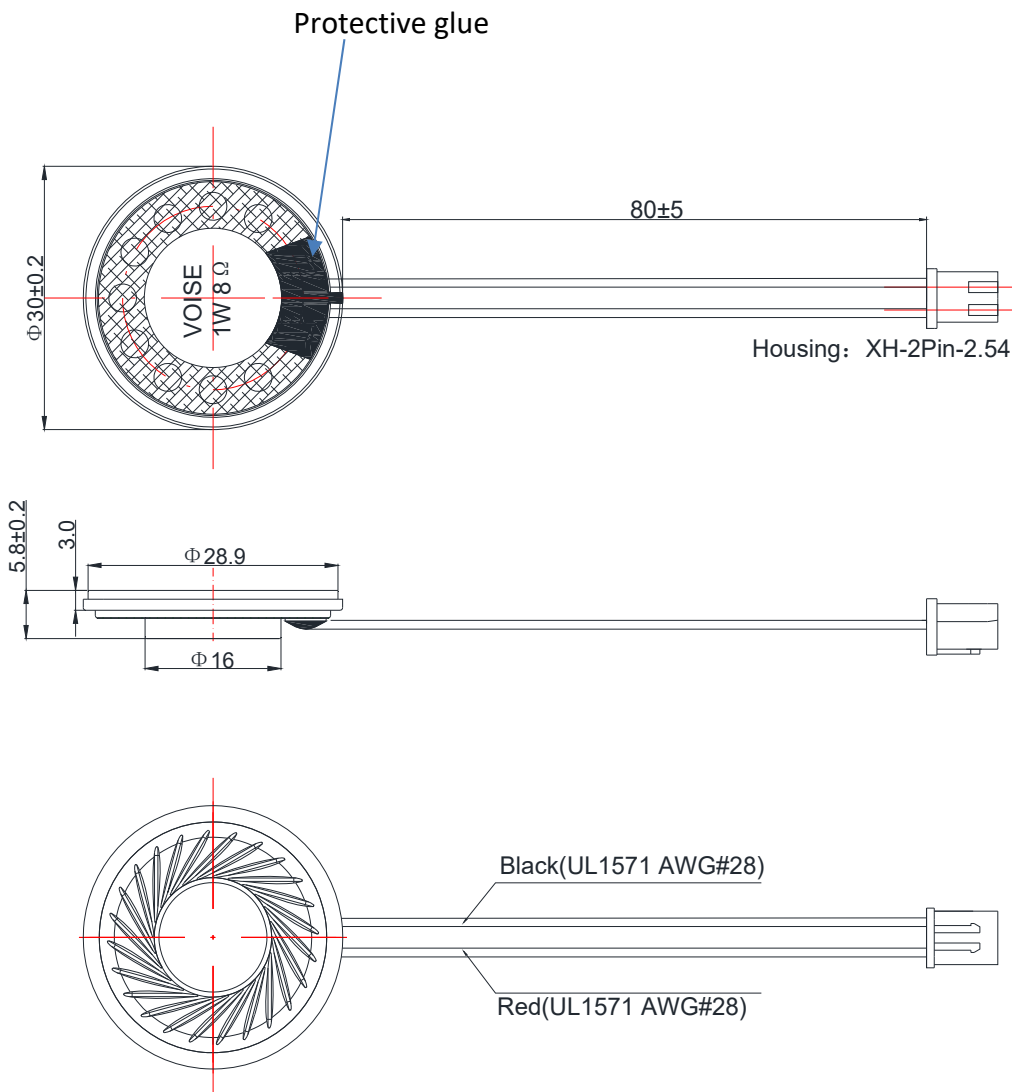

FIRST ANGLE PROJECTION

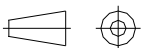

UNIT : mm

Tolerance : ± 0.2

Specification for Dynamic Speaker		Page	8/8
		Revision No.	1.1
Model No.:	VS3051R8F550P1C80	Drawing No.	VS20210928012

9. Packing

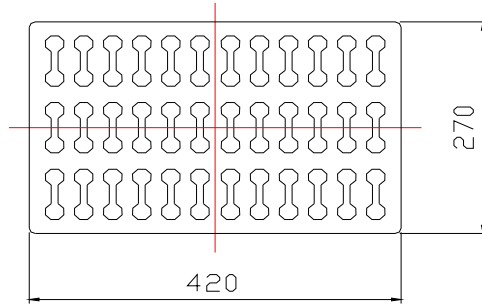

72Pcs

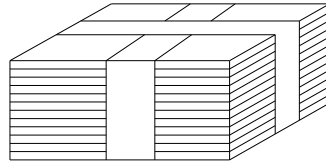

720x2Pcs

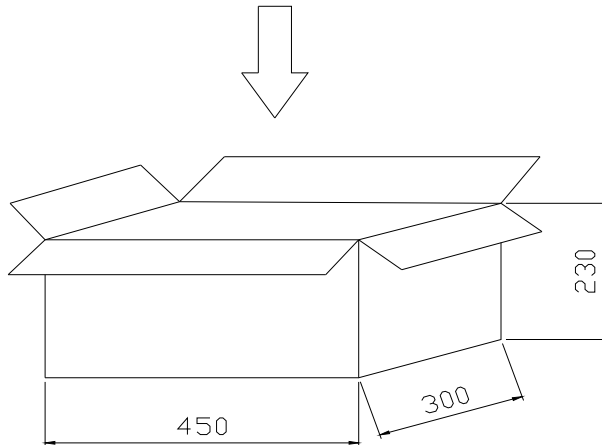

72 pcs per tray

20 trays for unit, 2 units per carton

Total:1440 pcs per box

Size:45×30×23cm