

## Specification for Speaker

Model No.	VS50200R8F280P2	Drawing No.	VS20221229011
Customer			

NO.	Items	Specification	Test Condition
1	Impedance	8Ω ±15%	at 1Vrms,0.8kHz
2	Resonant Fr. (fo)	280Hz±20%	
3	Frequency Range	F0-20KHz	
4	Rated Power	2W	
5	Max Power	3W	
6	S.P.L.	90dB±3dB	(0.1W/0.1M at0.8,1.0,1.2,1.5kHz Ave)
7	Distortion	<5% Max.	at 2kHz/2Vrms
8	Sweep Test	must be normal	at sine wave 4.0 V
9	Load Test	after test meet item 8	rated white noise power, 96 Hrs.
10	Heat Test	after test meet item 8	+60±2°C 20~50% 96Hrs.
11	Cold Test	after test meet item 8	-30±3°C 96Hrs.
12	Humidity Test	after test meet item 8	+40±2°C,90~95% 96Hrs.
13	Weight	12±5%g	
14	Polarity Test	with positive D.C. voltage to (+) terminal, the cone shall move forward.	
15	Note	IP60	

### Frequency Response Curve

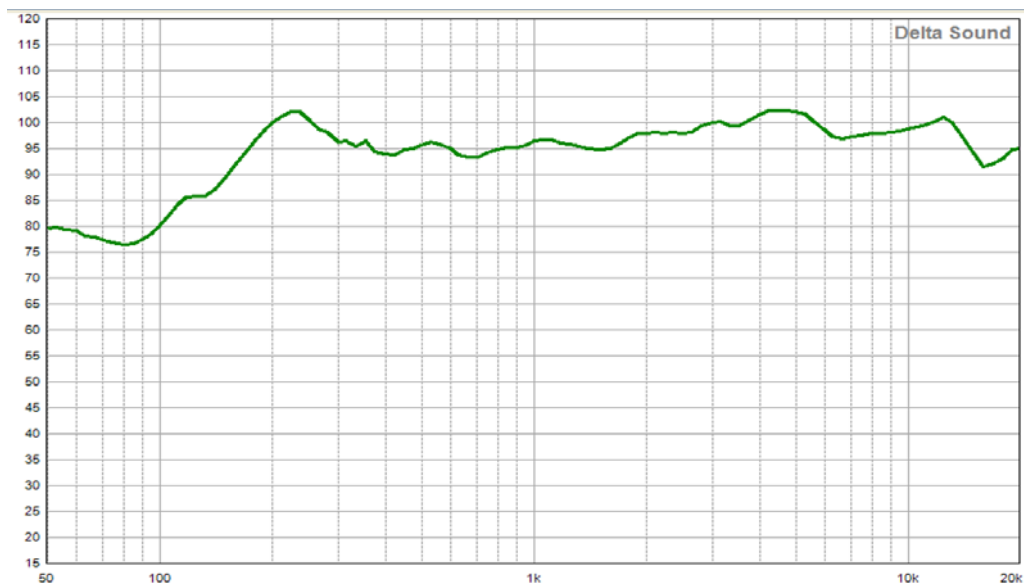

# Specification for Speaker

Model No. VS50200R8F280P2

Drawing No. VS20221229011

Dimensions:

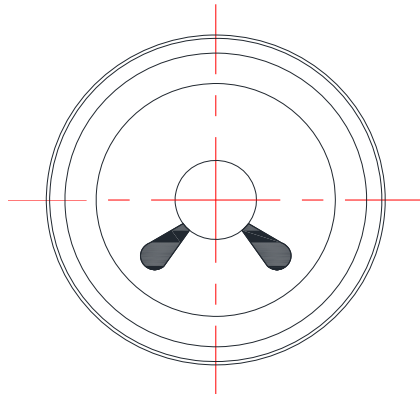
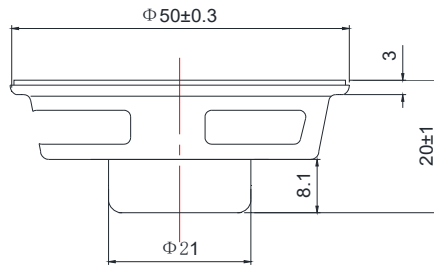
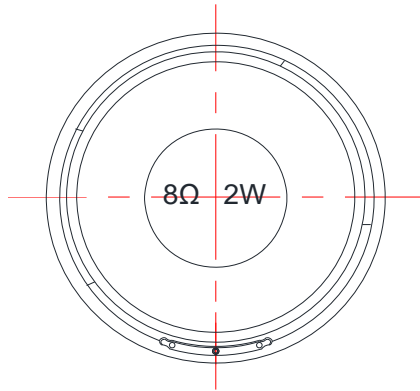

Unit : mm

Tolerance :  $\pm 0.2$