

Push Button Switch

Q-9657

TYPE: **DS-510**

SPECIFICATIONS

Rating: 1A 250V AC
Contact R: 35mΩ max
Insulation R: 500V DC 100MΩ min
Dielectric Strength: 1 Minute 1000V AC
Operating Temperature: -25°C ~ +85°C
Electrical Life: 10, 000 Cycles

Outline Drawing

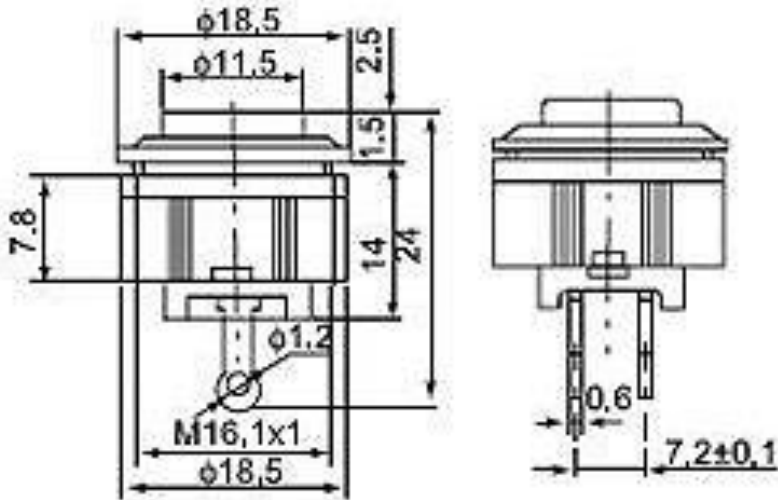

Mounting

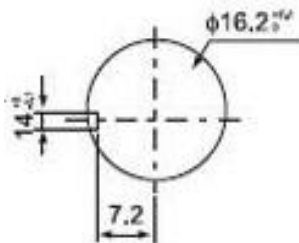

Circuitry

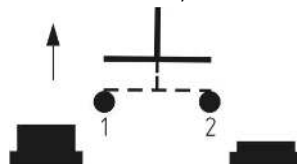

OFF - ON