

VTR RF Modulator

Description

CXA1122AP is a VTR RF modulator for the VHF band, and is used to convert frequencies of audio signals and video signals.

This modulator consists of circuits such as video clamp, white clipping, a carrier oscillator, video modulator, audio FM modulator, frequency/channel switch, and antenna switch driver.

Features

- Operates with low voltage and low consumption power. ($V_{cc} = 5\text{ V}$, $I_{cc} = 17.5\text{ mA}$, $I_{cont} = 20\text{ to }25\text{ mA}$)
- Low radiation and harmonic products.
- Provided with few external devices.
- Permits two channels in the VHF band.
- Provided with a built-in regulator and is resistant to power source changes.
- Allows video input of 0.5 V_{p-p} and various uses.
- Supports a one-mixer system to simplify the RF unit design.
- Permits the signal ratio of video to audio to be adjusted with an external capacitor.
- Provided with a carrier-off SW function for boss audio.
- Has a built-in antenna switch driver.
- Has a wide oscillation margin for a SAW (Surface Acoustic Wave) resonator.

Structure

Bipolar silicon monolithic IC

Block Diagram

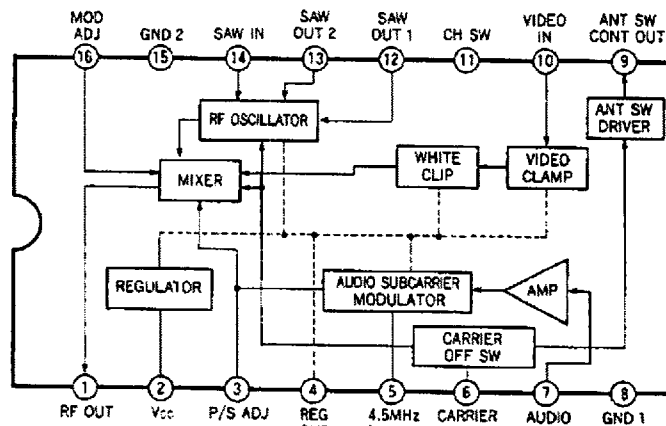

Package Outline

Unit: mm

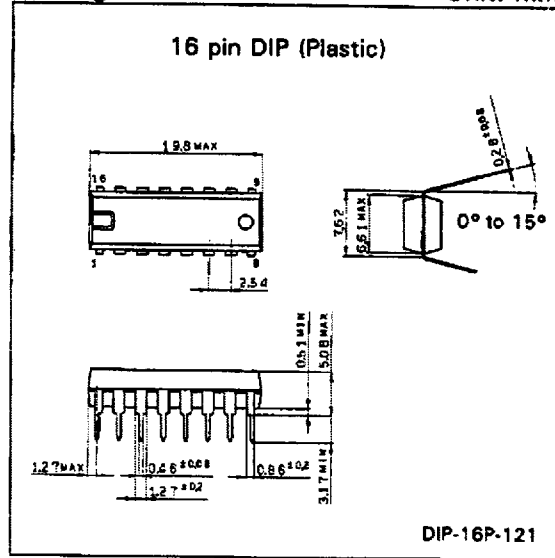

Absolute Maximum Ratings ($T_a = 25^\circ\text{C}$)

- Supply voltage V_{cc} 12 V
- Operating temperature T_{opr} $-20\text{ to }+75^\circ\text{C}$
- Storage temperature T_{stg} $-55\text{ to }+150^\circ\text{C}$
- Allowable power P_D 550 mW dissipation

Recommended Operating Condition

- Supply voltage V_{cc} 4.4 to 9.3 V

Pin Description and Equivalent Circuits

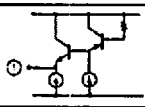
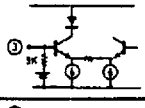
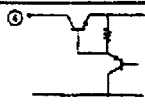
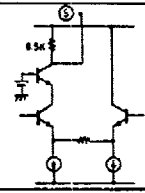
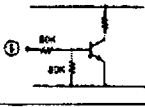
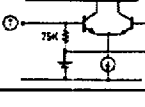
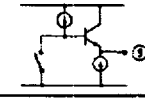
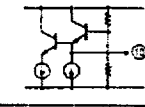
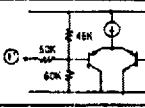
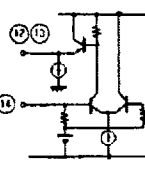
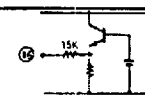
No.	Symbol	Voltage typical value (V)	Equivalent circuit	Description	
1	RF OUT	2.9		RF output pin (modulates video and audio FM signals into AM signals and outputs them.)	
2	Vcc			Vcc supply voltage pin	
3	P/S ADJ	1.8		P/S adjustment pin (The signal ratio of video to audio gets larger as capacitance is added between pin 3 and GND.)	
4	REG OUT	3.95		Regulator output pin.	
5	4.5 MHz TANK	3.05		Audio tank coil connecting pin	
6	CARRIER OFF SW	0		Carrier off switch (OPEN → carrier OFF, Vcc → carrier ON) The RF output can be switched to ON or OFF with the high-impedance input switch.	
7	AUDIO IN	1.95		Audio input pin	
8	GND1				
9	ANT SW DRIVER	4.0		Links up with pin 6 switch to supply the DC voltage output to the antenna switch circuit.	ON
		0		OFF	
10	VIDEO IN	2.6		Video input pin	
11	CH SW	2.3		Channel switch OPEN → GND LOW 0 to 0.7V High 2.3 to Vcc	
12	SAW OUT1	4.4, 3.7		Output 1 SAW resonator	
13	SAW OUT2	3.7, 4.4		Output 2 SAW resonator	
14	SAW IN	2.5		Input SAW resonator	
15	GND2				
16	MOD ADJ	0.80		Pin for slightly adjusting the modulation depth.	

Electrical Characteristics 1

(See the Electrical Characteristics Test Circuit)

 $T_a = 25^\circ\text{C}$, $V_{cc} = 5\text{ V}$

Item	Symbol	Test condition	Min.	Typ.	Max.	Unit
Supply current 1	lcc1	Pin 6 = High	14	17.5	22	mA
Supply current 2	lcc2	Pin 6 = Low	7.5	9.5	12	mA
ANT SW CONT	lcont	Pin 6 = High, lcont = 25 mA load	3.7	4.0	4.3	V
Video output level	Vo(fp1)	$V_1 = \text{No input}$	85.5	88.0	90.5	dB μ
	Vo(fp2)	V_{o1} output level *1				
Video output level temperature stability	$\Delta V_o(fp1)$	$V_o(fp1)$ ($T_a = -10$ to $+70^\circ\text{C}$) – $V_o(fp1)$ ($T_a = 25^\circ\text{C}$) –	–	–	± 2	dB
	$\Delta V_o(fp2)$	$V_o(fp2)$ ($T_a = -10$ to $+70^\circ\text{C}$) – $V_o(fp1)$ ($T_a = 25^\circ\text{C}$) –				
Video modulation depth	mp1	$V_1 = 0.5\text{ V}_{p-p}$ WHITE	72	78	84	%
	mp2	V_o modulation depth				
Video modulation depth temperature stability	$\Delta mp1$	mp1 ($T_a = -10$ to $+70^\circ\text{C}$) – mp1 ($T_a = 25^\circ\text{C}$)	–	–	± 2.5	%
	$\Delta mp2$	mp2 ($T_a = -10$ to $+70^\circ\text{C}$) – mp2 ($T_a = 25^\circ\text{C}$)				
Video modulation depth difference between channels	Δmp	mp1 – mp2	–	± 0.2	± 2	%
Maximum video modulation depth	$\Delta mp2$ (Max.)	$V_1 = 1.0\text{ V}_{p-p}$, WHITE V_o modulation depth *2 $\Delta mp2 = mp2 - mp2$ (max) (max)	11.5	15.0	18.5	%
920 kHz beat	Vb	$V_1 = 0.5\text{ V}_{p-p}$ sin 3.58-MHz input *3	64	70	–	dB
Sync-crush level	$\Delta Sync$	$V_1 = 0.5\text{ V}_{p-p}$, WHITE V_o output $1 - \left\{ \frac{V_{Sync}}{V_{White}} \times \frac{100}{40} \right\}$	–	–	10	%
Differential gain	DG1	$V_1 = 0.5\text{ V}_{p-p}$, STAIR STEP	–	1	3	%
	DG2	V_o DG *4				
Differential phase	DP1	$V_1 = 0.5\text{ V}_{p-p}$, STAIR STEP	–	2	5	deg
	DP2	V_o DP *4				
Video higher-harmonic wave ratio	VvH	$V_1 = 0.5\text{ V}_{p-p}$, 1 MHz CW *5	–	–56	–46	dB
RF carrier ratio of video to audio	Vps	$V_1 = \text{no Video Signal}$, $C_1 = 3\text{ pF}$	11.5	13.5	15.5	dB
Audio FM Central frequency temperature stability	Δfs	$S_1 = 1$, $F_s = V_{o2}$ frequency $fs(T_a = 0$ to $60^\circ\text{C}) - fs(T_a = 25^\circ\text{C})$ *6				
Audio FM modulation sensitivity *	βS	$S_1 = 1$, $C_2 = 39\text{ pF}$ $V_2 = \text{pin 7 DC voltage } \pm 0.2\text{ V}$ fs frequency change/0.4 V *7	0.445	0.555	0.665	kHz/mV
Audio total harmonic distortion ratio	THD	$S_1 = 1$, $V_2 = 1\text{ kHz}$ *8	–	0.30	0.8	%
Audio S/N	ASN	The audio S/N is 0 dB at 60% modulation	55	59	–	dB
Maximum audio FM modulation depth	ms(Max.)	$S_1 = 1$, $V_2 = \text{pin 7 DC voltage } \pm 1.0\text{ V}$ FS frequency change/50 kHz $\times 100$	400	–	–	%

*** Classifications**

Marking	Audio FM modulation sensitivity (kHz/mV)
A1122AP-3	0.665 to 0.577
A1122AP-1	0.595 to 0.515
A1122AP-2	0.533 to 0.445

Electrical Characteristics 2 (Design security items: This parameter is not 100% tested.)

1. Video S/N	Min. 50 dB Typ. 58 dB
2. Video amplitude frequency characteristic (based on 1 MHz)	Within ± 1 dB for 0.5 to 5 MHz
3. Audio amplitude frequency characteristic (based on 1 kHz)	Within ± 1 dB for 0.1 to 60 kHz

- Note) *1.** Measure the V_o output level using the spectrum analyzer with a 50Ω input impedance and convert measured value V_o into decibels (dBm) using the following expression:
 $Output (dB\mu) = V_o (dBm) + 113$
- *2. The difference in image modulation depth between the maximum modulation depth at an input of 0.5 Vp-p and at an input of 1.0 Vp-p.
 - *3. Directly-read value (dB) of the component ratio of the 920 kHz beat to the video carrier level measured with a spectrum analyzer
 - *4. Measured with the standard-type demodulator after demodulation.
 - *5. $f_c + 2$ MHz or $f_c + 3$ MHz level to the V_o carrier (f_c) level
 - *6. Adjust f_s to 4.500 MHz with $T_a = 25^\circ C$.
 - *7. A 15 k Ω resistor is added in series for pre-emphasis so that a better match can be obtained between audio modulation sensitivity classifications.
 - *8. Adjust the V_2 level so that the FM deviation is ± 15 kHz and measure the total harmonic distortion after demodulating V_o with the standard-type demodulator.

Input Waveforms

WHITE signal

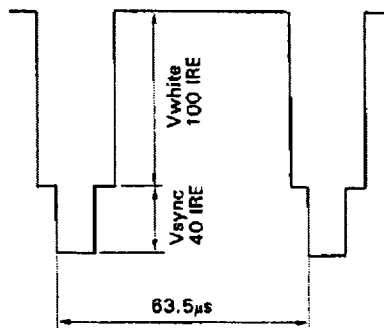

STAIR STEP signal

APL 50% subcarrier 20 IRE

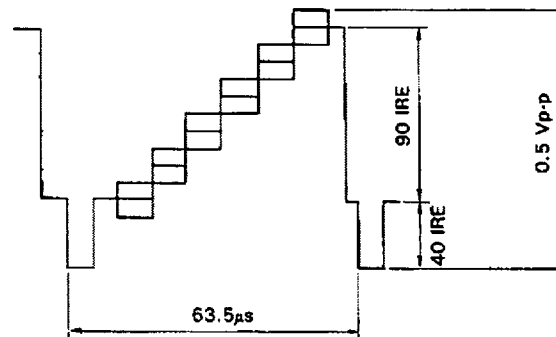

Electrical Characteristics Test Circuit

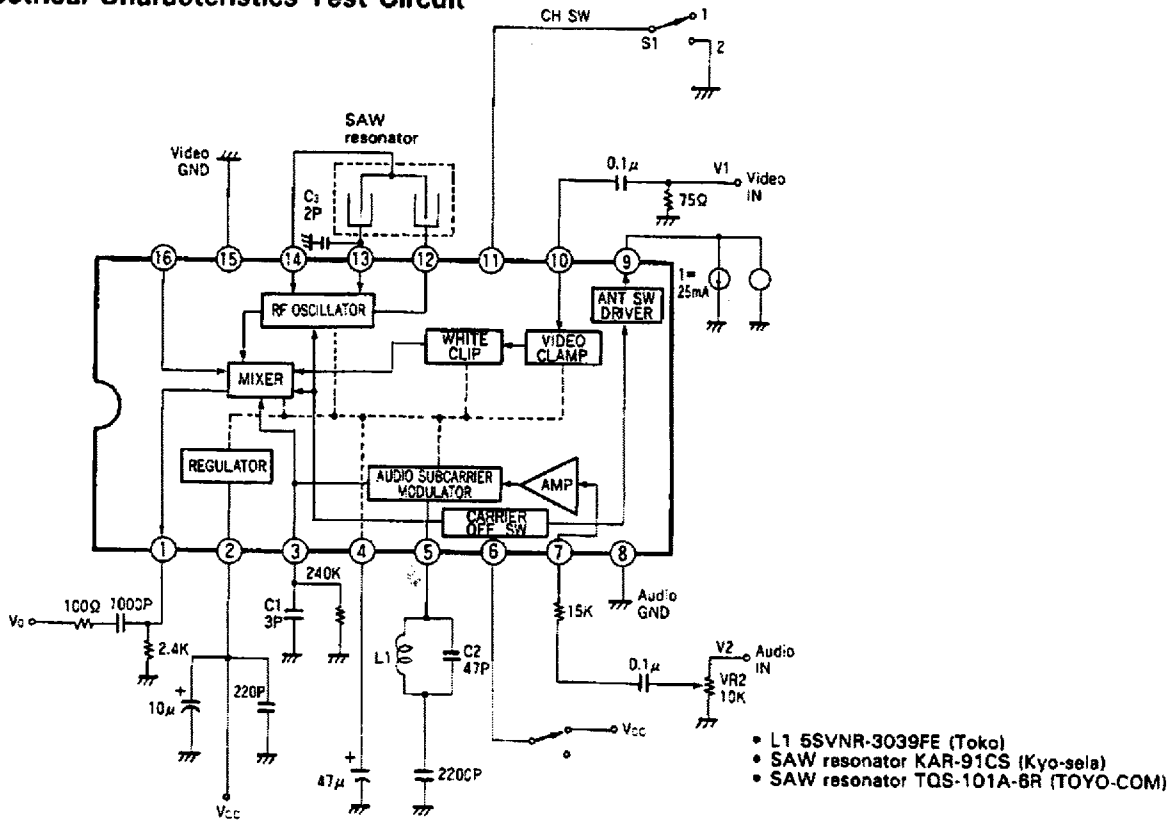

Application Circuit

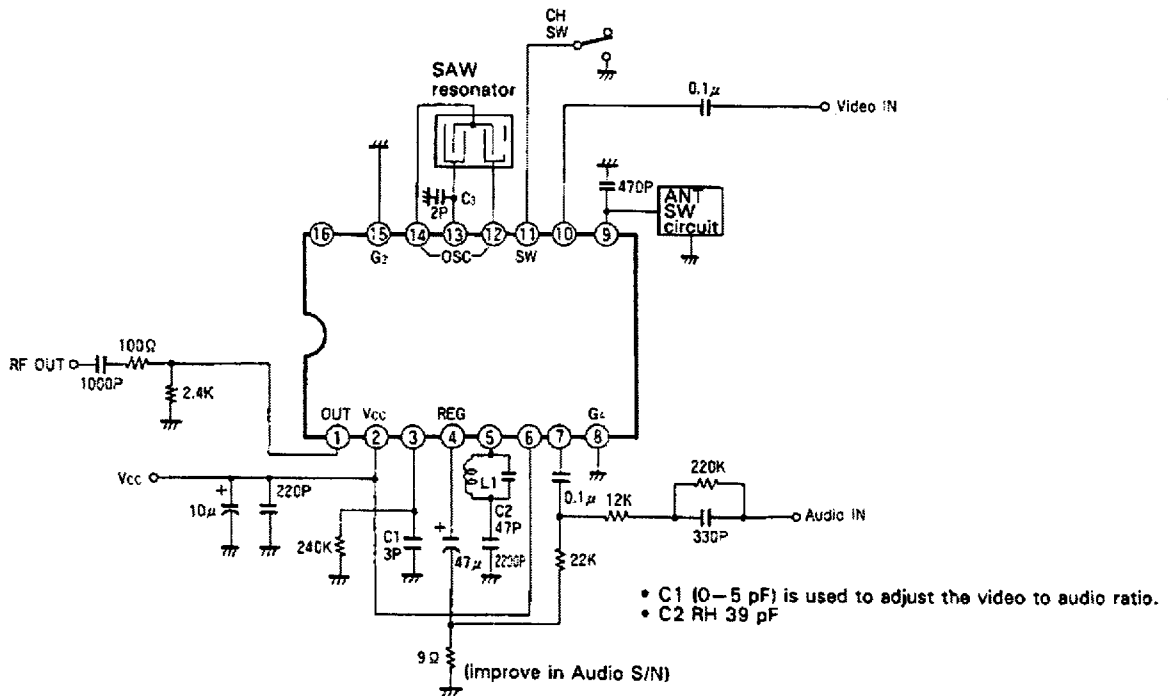

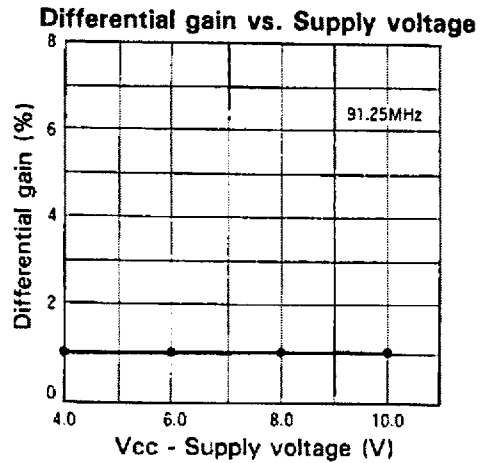
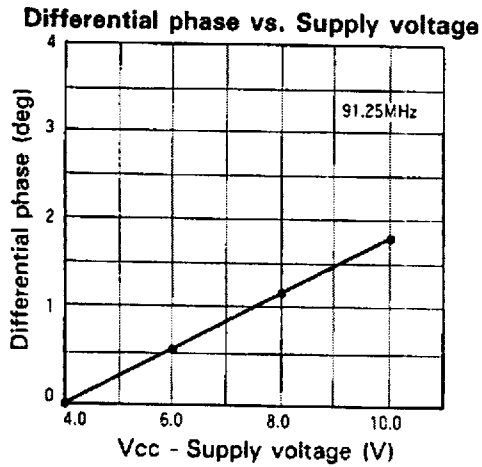
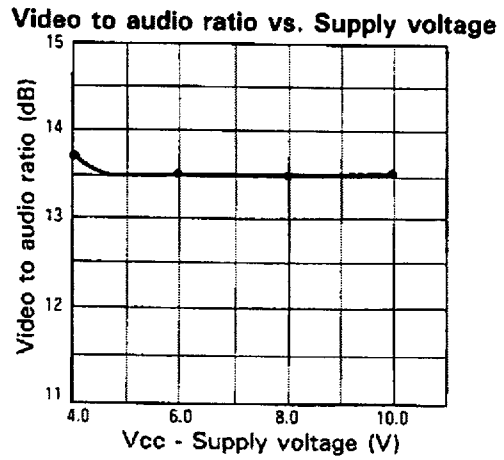
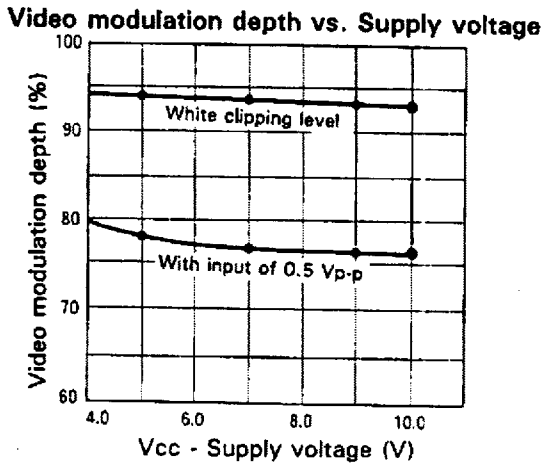
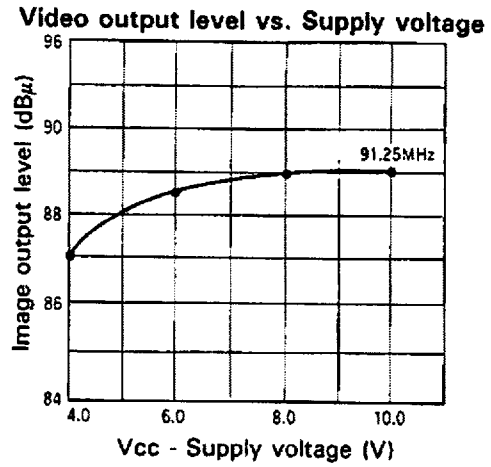
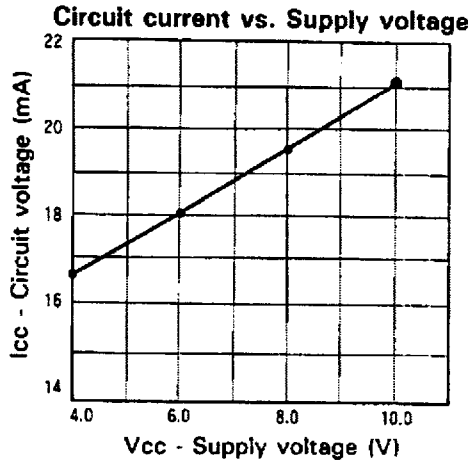

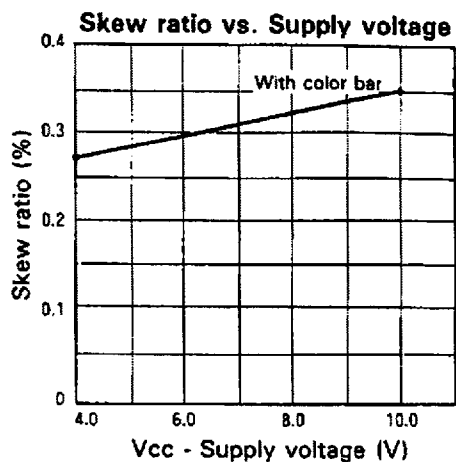
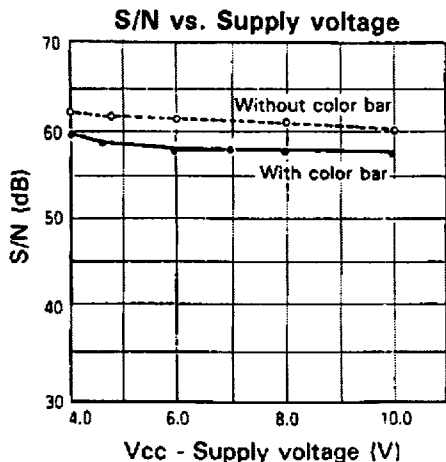

ANT SW driver load vs. Voltage characteristic

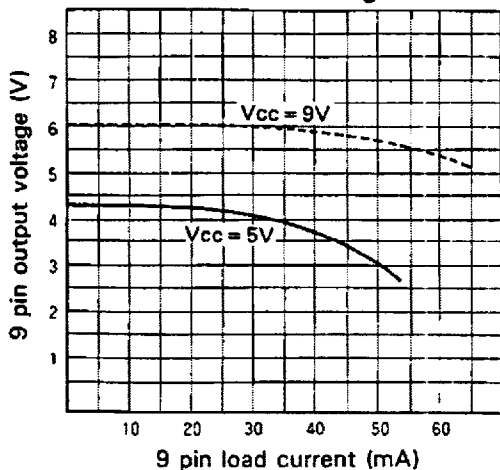

920 kHz beat vs. Supply voltage

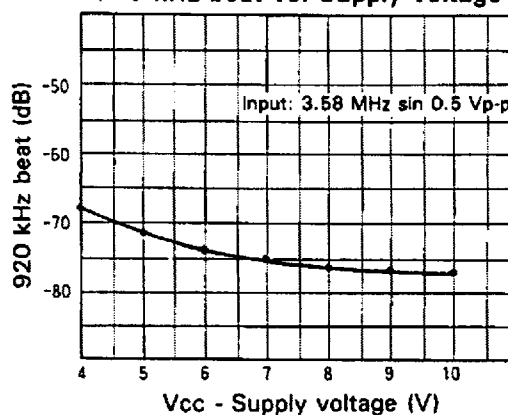

Inter-carrier change vs. Supply voltage

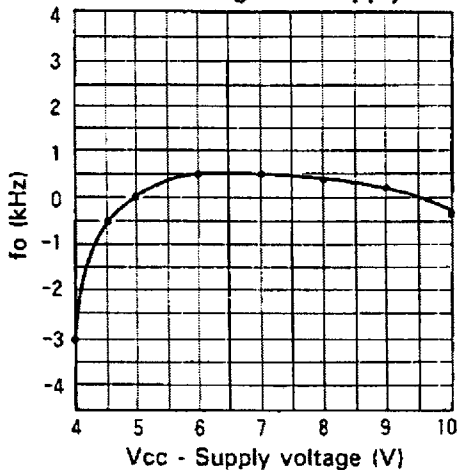

Supply ripple characteristics

Techtronics AA501
DISTORTION ANALYZER
Rms measurement

