

Specification for Speaker

Model No.	VS50x50R8F650P3	Drawing No.	VS20231203008
Customer			

SPEC

NO.	Items	Specification	Test Condition
1	Impedance	8 Ω ±15%	at 1Vrms,0.8kHz
2	Resonant Fr. (fo)	650Hz±20%	
3	Frequency Range	F0-6KHz	
4	Rated Power	3W	
5	Max Power	4W	
6	S.P.L.	90dB±3dB	(0.1W/0.1M at0.8,1.0,1.2,1.5kHz Ave)
7	Distortion	<10% Max.	at 2kHz/2Vrms
8	Sweep Test	must be normal	at sine wave 4.89 V
9	Load Test	after test meet item 8	rated white noise power, 96 Hrs.
10	Heat Test	after test meet item 8	+60±2℃ 20~50% 96Hrs.
11	Cold Test	after test meet item 8	-20±3℃ 96Hrs.
12	Humidity Test	after test meet item 8	+40±2℃,90~95% 96Hrs.
13	Weight	27g	
14	Polarity Test	with positive D.C. voltage to (+) terminal, the cone shall move forward.	
15	Waterproof	IP60	

Frequency Response Curve

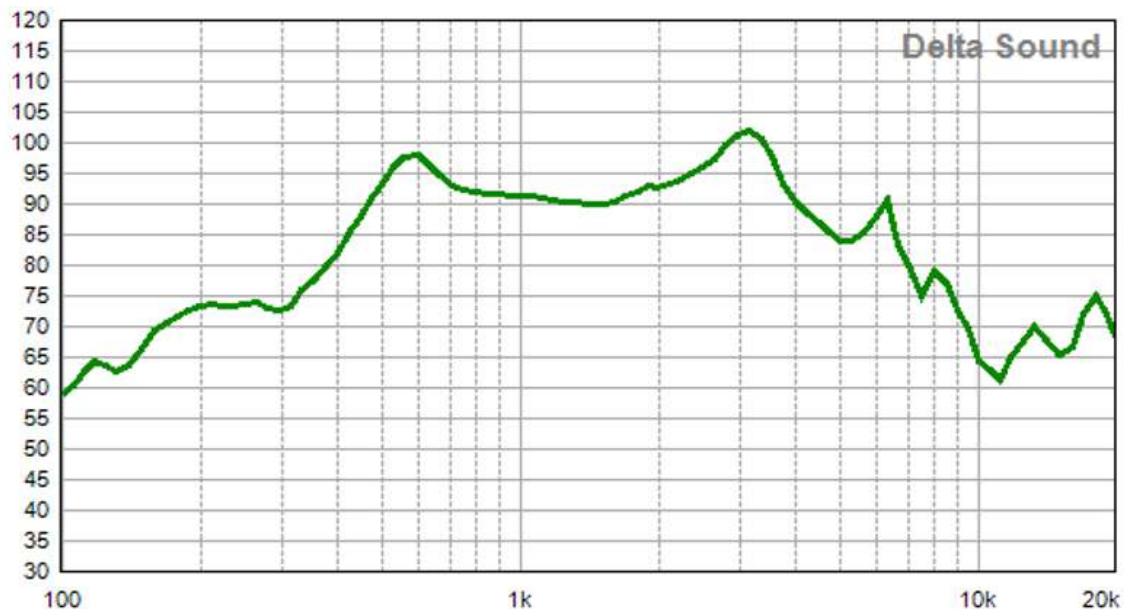

Specification for Speaker

Model No. VS50x50R8F650P3

Drawing No.

VS20231203008

Dimensions:

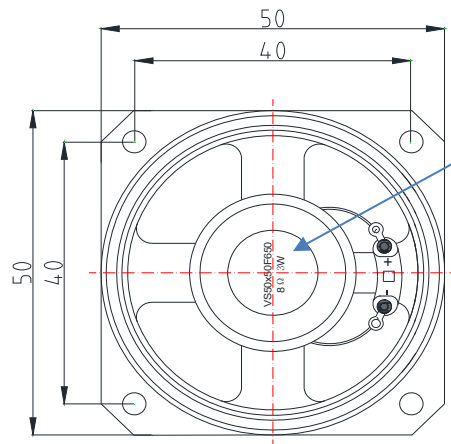

Marking:
VS50x50F650
8Ω 3W

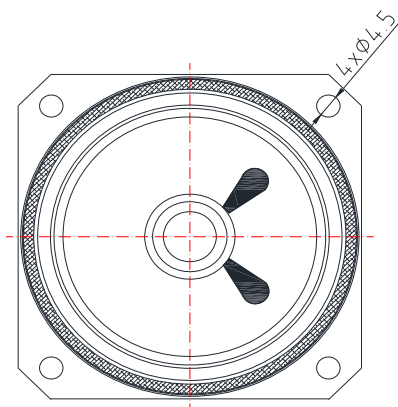
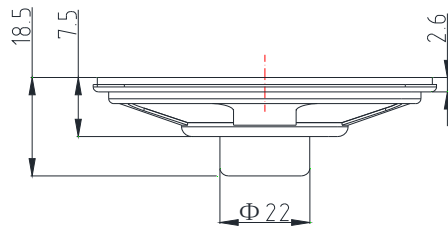

Unit : mm

Tolerance : ±0.2